

Frässtifte VHM-Mini

VORTEILE

- ▶ Hohe Formgenauigkeit
- ▶ Hohe Rundlaufgenauigkeit, daher große Laufruhe
- ▶ Universalverzahnung
- ▶ Hergestellt aus Feinkornhartmetall
- ▶ Feinst geschliffene Schneiden

EINSATZGEBIETE

- ▶ Werkzeugbau
- ▶ Feinmechanik
- ▶ Schmuckindustrie
- ▶ Turbinenbau

ZU BEARBEITENDE

WERKSTOFFE

- ▶ Edelstähle
- ▶ Buntmetalle
- ▶ Zinkdruckguss
- ▶ Weiche Keramiken
- ▶ Titanlegierungen

ANWENDUNGSHINWEISE

- ▶ Möglichst kurz spannen
- ▶ Auf exakten Rundlauf der Spannzange achten
- ▶ Max. Drehzahl: 70.000 min⁻¹

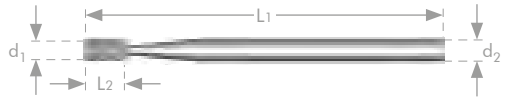

| d_1 | d_2 | L_2 | L_1 | Bestell-Nr Universalverzahnung | Stk |
|-------|-------|-------|-------|-----------------------------------|-------|
| 1,0 | 3,0 | 4,0 | 40 | 258-A010-03 | 17,00 |
| 1,5 | 3,0 | 4,0 | 40 | 258-A015-03 | 17,00 |
| 2,0 | 3,0 | 4,0 | 40 | 258-A020-03 | 17,00 |



| | | | | | |
|-----|-----|-----|----|--------------------|-------|
| 1,0 | 3,0 | 4,0 | 40 | 258-C010-03 | 17,00 |
| 1,5 | 3,0 | 4,0 | 40 | 258-C015-03 | 17,00 |
| 2,0 | 3,0 | 4,0 | 40 | 258-C020-03 | 17,00 |



| | | | | | |
|-----|-----|--|----|--------------------|-------|
| 1,0 | 3,0 | | 40 | 258-D010-03 | 17,20 |
| 1,5 | 3,0 | | 40 | 258-D015-03 | 17,20 |
| 2,0 | 3,0 | | 40 | 258-D020-03 | 17,20 |



| | | | | | |
|-----|-----|-----|----|--------------------|-------|
| 1,5 | 3,0 | 4,0 | 40 | 258-E015-03 | 17,20 |
|-----|-----|-----|----|--------------------|-------|



| | | | | | |
|-----|-----|-----|----|--------------------|-------|
| 1,5 | 3,0 | 4,0 | 40 | 258-F015-03 | 17,00 |
|-----|-----|-----|----|--------------------|-------|



| | | | | | |
|-----|-----|-----|----|--------------------|-------|
| 1,5 | 3,0 | 4,0 | 40 | 258-G015-03 | 17,00 |
|-----|-----|-----|----|--------------------|-------|



| | | | | | |
|-----|-----|-----|----|--------------------|-------|
| 1,5 | 3,0 | 4,0 | 40 | 258-M015-03 | 17,20 |
|-----|-----|-----|----|--------------------|-------|

Verzahnungsauswahl



Kreuzverzahnung
Sehr gute Spanabnahme, kleine Späne



Normalverzahnung
Sehr gute Spanabnahme, gute Oberfläche



Aluverzahnung
Große Spanräume, gute Schneidwirkung



Normalverzahnung
Mit Spanbrecher
Ähnlich Normalverzahnung, jedoch kürzere Späne



Diamantverzahnung
Für harte und spröde Werkstoffe



Grobverzahnung
Größere Spanräume für erhöhten Spanabtrag



Feinverzahnung
Für harte und spröde Werkstoffe, gute Oberfläche

| Werkstoff | Verzahnung | | | | | | |
|-------------------------|------------|---|---|-----|---|---|---|
| | 6 | 3 | 1 | 3SP | 4 | 2 | 5 |
| Aluminium | | | ● | | | | |
| Messing, Kupfer, Bronze | ● | ● | | ● | | ● | |
| Kohlefaser | | | | | | ● | |
| Glasfaser | | | | | ● | | |
| Gusseisen | ● | ● | | ● | | | |
| Kunststoff | | | ● | | | ● | |
| Hartgummi | | | | | | ● | |
| Stahl > 55 HRC | ● | ● | | ● | ● | | ● |
| Stahl > 60 HRC | ● | ● | | ● | ● | | ● |
| Stahl | ● | ● | | ● | | | |
| Rostfreier Stahl | ● | ● | | ● | | | ● |
| Nickellegierungen | ● | ● | | ● | ● | | |
| Schweißteile | ● | ● | | ● | | | |
| Titan | ● | ● | | ● | | | |
| Zink | | | ● | | | ● | |

**Langschafffrässtifte sind mit reduzierter Drehzahl einzusetzen!**

Bei Anwendungen mit schnelllaufenden Werkzeugen ist aus Sicherheitsgründen eine Schutzbrille zu tragen!

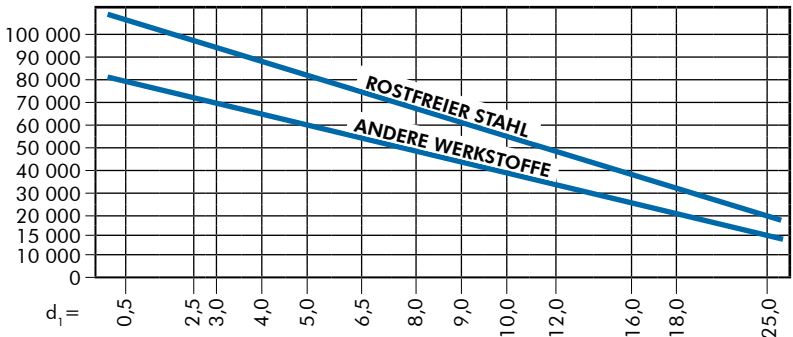

VHM-Frässtifte Zylinderform (SA)

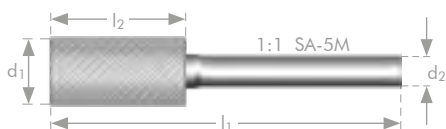
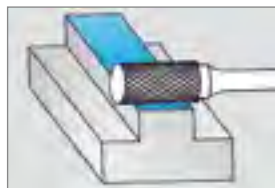

| Schaft Ø 3 mm | d ₁ | d ₂ | l ₂ | l ₁ |
|------------------|----------------|----------------|----------------|----------------|
| SA-41M | 1,5 | 3,0 | 6,0 | 38 |
| SA-42M | 2,5 | 3,0 | 11,0 | 38 |
| SA-43M | 3,0 | 3,0 | 14,0 | 38 |
| SA-52M | 4,0 | 3,0 | 12,7 | 38 |
| SA-53M | 5,0 | 3,0 | 12,7 | 38 |
| SA-51M | 6,3 | 3,0 | 12,7 | 50 |

| Bestell-Nr Kreuzverzahnung | Bestell-Nr Normalverzahnung | Stk |
|-------------------------------|--------------------------------|-------|
| 258-20603 | 258-20600 | 7,65 |
| 258-20628 | 258-20625 | 7,65 |
| 258-20653 | 258-20650 | 7,65 |
| 258-20703 | 258-20700 | 18,45 |
| 258-20728 | 258-20725 | 18,45 |
| 258-20678 | 258-20675 | 12,55 |

| Schaft Ø 6 mm | d ₁ | d ₂ | l ₂ | l ₁ |
|------------------|----------------|----------------|----------------|----------------|
| SA-11M | 3,0 | 6,0 | 12,0 | 56 |
| SA-12M | 3,0 | 6,0 | 12,7 | 60 |
| SA-13M | 4,0 | 6,0 | 16,0 | 50 |
| SA-14M | 5,0 | 6,0 | 16,0 | 50 |
| SA-1M | 6,0 | 6,0 | 16,0 | 50 |
| SA-1ML | 6,0 | 6,0 | 25,0 | 50 |
| SA-2M | 8,0 | 6,0 | 19,0 | 63 |
| SA-3M | 9,5 | 6,0 | 19,0 | 63 |
| SA-3ML | 9,5 | 6,0 | 25,0 | 69 |
| SA-3MZ | 10,0 | 6,0 | 20,0 | 60 |
| SA-4M | 11,0 | 6,0 | 25,0 | 69 |
| SA-5MZ | 12,0 | 6,0 | 25,0 | 65 |
| SA-5M | 12,7 | 6,0 | 25,0 | 69 |
| SA-6M | 16,0 | 6,0 | 25,0 | 69 |
| SA-7M | 19,0 | 6,0 | 25,0 | 69 |
| SA-9M | 25,0 | 6,0 | 25,0 | 69 |

| Bestell-Nr Kreuzverzahnung | Bestell-Nr Normalverzahnung | Stk |
|-------------------------------|--------------------------------|-------|
| 258-20403 | 258-20400 | 12,70 |
| 258-20428 | 258-20425 | 12,70 |
| 258-20453 | 258-20450 | 12,70 |
| 258-20478 | 258-20475 | 12,70 |
| 258-20003 | 258-20000 | 12,70 |
| 258-20028 | 258-20025 | 18,45 |
| 258-20053 | 258-20050 | 16,65 |
| 258-20078 | 258-20075 | 17,95 |
| 258-20103 | 258-20100 | 21,30 |
| 258-29101 | 258-29100 | 17,95 |
| 258-20153 | 258-20150 | 25,90 |
| 258-29105 | 258-29104 | 27,95 |
| 258-20178 | 258-20175 | 27,95 |
| 258-20203 | 258-20200 | 35,20 |
| 258-20253 | 258-20250 | 52,40 |
| 258-20353 | 258-20350 | 73,25 |

VHM-Frässtifte Zylinderform Langschaftfrässtifte

Schaft Ø 3 mm - 6 mm

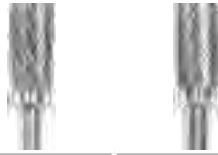

| Schaft Ø 3 mm | d ₁ | d ₂ | l ₂ | l ₁ |
|------------------|----------------|----------------|----------------|----------------|
| SA-41ML2 | 1,5 | 3,0 | 6,0 | 50 |
| SA-41ML3 | 1,5 | 3,0 | 6,0 | 75 |
| SA-42ML2 | 2,5 | 3,0 | 11,0 | 50 |
| SA-42ML3 | 2,5 | 3,0 | 11,0 | 75 |
| SA-43ML2 | 3,0 | 3,0 | 14,0 | 50 |
| SA-43ML3 | 3,0 | 3,0 | 14,0 | 75 |

| Bestell-Nr Kreuzverzahnung | Bestell-Nr Normalverzahnung | Stk |
|-------------------------------|--------------------------------|-------|
| 258-27103 | 258-27100 | 10,60 |
| 258-27128 | 258-27125 | 12,00 |
| 258-27153 | 258-27150 | 10,60 |
| 258-27178 | 258-27175 | 12,00 |
| 258-27203 | 258-27200 | 10,60 |
| 258-27228 | 258-27225 | 12,00 |

| Schaft Ø 6 mm | d ₁ | d ₂ | l ₂ | l ₁ |
|------------------|----------------|----------------|----------------|----------------|
| SA-1ML6 | 6,0 | 6,0 | 12,7 | 162 |
| SA-3ML6 | 9,5 | 6,0 | 19,0 | 169 |
| SA-5ML6 | 12,7 | 6,0 | 25,0 | 175 |

| Bestell-Nr Kreuzverzahnung | Bestell-Nr Normalverzahnung | Stk |
|-------------------------------|--------------------------------|-------|
| 258-26178 | 258-26175 | 17,80 |
| 258-26203 | 258-26200 | 25,05 |
| 258-26228 | 258-26225 | 39,10 |

VHM-Frässtifte Zylinderform - Aluminiumverzahnung

Schaft Ø 6 mm

| Schaft Ø 6 mm | d ₁ | d ₂ | l ₂ | l ₁ |
|------------------|----------------|----------------|----------------|----------------|
| SA-1MNF | 6,0 | 6,0 | 19,0 | 50 |
| SA-3MNF | 9,5 | 6,0 | 19,0 | 63 |
| SA-5MNF | 12,7 | 6,0 | 25,0 | 69 |
| SA-6MNF | 16,0 | 6,0 | 25,0 | 69 |
| SA-7MNF | 19,0 | 6,0 | 25,0 | 69 |

| Bestell-Nr Aluverzahnung | Stk |
|-----------------------------|-------|
| 258-29000 | 17,25 |
| 258-29002 | 25,90 |
| 258-29004 | 37,95 |
| 258-29006 | 46,55 |
| 258-29008 | 63,95 |



VHM-Frässtifte Zylinderform mit Stirnverzahnung (SB)

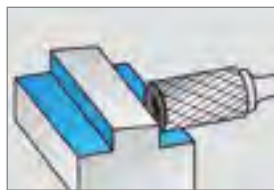
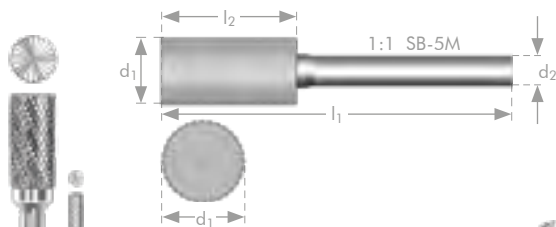

| Schaft Ø 3 mm | d ₁ | d ₂ | l ₂ | l ₁ |
|------------------|----------------|----------------|----------------|----------------|
| SB-41M | 1,5 | 3,0 | 6,0 | 38 |
| SB-42M | 2,5 | 3,0 | 11,0 | 38 |
| SB-ECOM | 3,0 | 3,0 | 0,0 | 38 |
| SB-43M | 3,0 | 3,0 | 14,0 | 38 |
| SB-51M | 6,3 | 3,0 | 12,7 | 38 |

| Bestell-Nr Kreuzverzahnung | Bestell-Nr Normalverzahnung | Stk |
|-------------------------------|--------------------------------|-------|
| 258-21453 | 258-21450 | 7,65 |
| 258-21478 | 258-21475 | 7,65 |
| - | 258-21525 | 7,65 |
| 258-21503 | 258-21500 | 7,65 |
| 258-21553 | 258-21550 | 12,55 |

| Schaft Ø 6 mm | d ₁ | d ₂ | l ₂ | l ₁ |
|------------------|----------------|----------------|----------------|----------------|
| SB-11M | 3,0 | 6,0 | 12,0 | 56 |
| SB-12M | 3,0 | 6,0 | 12,7 | 60 |
| SB-13M | 4,0 | 6,0 | 16,0 | 50 |
| SB-14M | 5,0 | 6,0 | 16,0 | 50 |
| SB-1M | 6,0 | 6,0 | 16,0 | 50 |
| SB-1ML | 6,0 | 6,0 | 25,0 | 50 |
| SB-2M | 8,0 | 6,0 | 19,0 | 63 |
| SB-3M | 9,5 | 6,0 | 19,0 | 63 |
| SB-3ML | 9,5 | 6,0 | 25,0 | 69 |
| SB-3MZ | 10,0 | 6,0 | 20,0 | 60 |
| SB-4M | 11,0 | 6,0 | 25,0 | 69 |
| SB-5MZ | 12,0 | 6,0 | 25,0 | 65 |
| SB-5M | 12,7 | 6,0 | 25,0 | 69 |
| SB-6M | 16,0 | 6,0 | 25,0 | 69 |
| SB-7M | 19,0 | 6,0 | 25,0 | 69 |
| SB-9M | 25,0 | 6,0 | 25,0 | 69 |

| Bestell-Nr Kreuzverzahnung | Bestell-Nr Normalverzahnung | Stk |
|-------------------------------|--------------------------------|-------|
| 258-21253 | 258-21250 | 13,80 |
| 258-21278 | 258-21275 | 13,80 |
| 258-21303 | 258-21300 | 13,80 |
| 258-21328 | 258-21325 | 13,80 |
| 258-20853 | 258-20850 | 13,80 |
| 258-20873 | 258-20870 | 20,40 |
| 258-20903 | 258-20900 | 18,30 |
| 258-20928 | 258-20925 | 19,65 |
| 258-20953 | 258-20950 | 23,35 |
| 258-29109 | 258-29108 | 19,65 |
| 258-21003 | 258-21000 | 28,60 |
| 258-29113 | 258-29112 | 30,70 |
| 258-21028 | 258-21025 | 30,70 |
| 258-21053 | 258-21050 | 38,65 |
| 258-21103 | 258-21100 | 57,60 |
| 258-21203 | 258-21200 | 80,60 |

VHM-Frässtifte Zylinderform mit Stirnverzahnung

Langschaftfrässtifte

Schaft Ø 3 mm



| Schaft Ø 3 mm | d ₁ | d ₂ | l ₂ | l ₁ |
|------------------|----------------|----------------|----------------|----------------|
| SB-41ML2 | 1,5 | 3,0 | 6,0 | 50 |
| SB-41ML3 | 1,5 | 3,0 | 6,0 | 75 |
| SB-42ML2 | 2,5 | 3,0 | 11,0 | 50 |
| SB-42ML3 | 2,5 | 3,0 | 11,0 | 75 |
| SB-43ML2 | 3,0 | 3,0 | 14,0 | 50 |
| SB-43ML3 | 3,0 | 3,0 | 14,0 | 75 |

| Bestell-Nr Kreuzverzahnung | Bestell-Nr Normalverzahnung | Stk |
|-------------------------------|--------------------------------|-------|
| 258-27253 | 258-27250 | 10,60 |
| 258-27278 | 258-27275 | 12,00 |
| 258-27303 | 258-27300 | 10,60 |
| 258-27328 | 258-27325 | 12,00 |
| 258-27353 | 258-27350 | 10,60 |
| 258-27378 | 258-27375 | 13,20 |

VHM-Frässtifte Zylinderform mit Stirnverzahnung - Aluminiumverzahnung

Schaft Ø 6 mm

| Schaft Ø 6 mm | d ₁ | d ₂ | l ₂ | l ₁ |
|------------------|----------------|----------------|----------------|----------------|
| SB-1MNF | 6,0 | 6,0 | 16,0 | 50 |
| SB-3MNF | 9,5 | 6,0 | 19,0 | 63 |
| SB-5MNF | 12,7 | 6,0 | 25,0 | 69 |
| SB-6MNF | 16,0 | 6,0 | 25,0 | 69 |
| SB-7MNF | 19,0 | 6,0 | 25,0 | 69 |

| Bestell-Nr Aluverzahnung | Stk |
|-----------------------------|-------|
| 258-29012 | 19,00 |
| 258-29014 | 28,50 |
| 258-29016 | 41,75 |
| 258-29018 | 51,25 |
| 258-29020 | 70,35 |



VHM-Frässtifte Walzenrundform (SC)

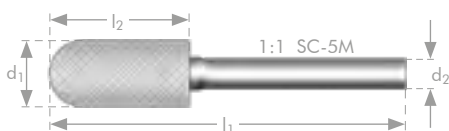

| Schaft Ø 3 mm | d ₁ | d ₂ | l ₂ | l ₁ |
|------------------|----------------|----------------|----------------|----------------|
| SC-41M | 2,5 | 3,0 | 11,0 | 38 |
| SC-42M | 3,0 | 3,0 | 14,0 | 38 |
| SC-52M | 4,0 | 3,0 | 12,7 | 38 |
| SC-43M | 5,0 | 3,0 | 14,0 | 38 |
| SC-51M | 6,3 | 3,0 | 12,7 | 38 |

| Bestell-Nr Kreuzverzahnung | Bestell-Nr Normalverzahnung | Stk |
|-------------------------------|--------------------------------|-------|
| 258-22253 | 258-22250 | 7,65 |
| 258-22278 | 258-22275 | 7,65 |
| 258-22328 | 258-22325 | 18,45 |
| 258-22353 | 258-22350 | 18,45 |
| 258-22303 | 258-22300 | 12,55 |

| Schaft Ø 6 mm | d ₁ | d ₂ | l ₂ | l ₁ |
|------------------|----------------|----------------|----------------|----------------|
| SC-11M | 3,0 | 6,0 | 12,0 | 56 |
| SC-12M | 3,0 | 6,0 | 12,7 | 60 |
| SC-13M | 4,0 | 6,0 | 16,0 | 50 |
| SC-14M | 5,0 | 6,0 | 16,0 | 50 |
| SC-1M | 6,0 | 6,0 | 16,0 | 50 |
| SC-1ML | 6,0 | 6,0 | 25,0 | 50 |
| SC-2M | 8,0 | 6,0 | 19,0 | 63 |
| SC-3M | 9,5 | 6,0 | 19,0 | 63 |
| SC-3ML | 9,5 | 6,0 | 25,0 | 69 |
| SC-3MZ | 10,0 | 6,0 | 20,0 | 60 |
| SC-4M | 11,0 | 6,0 | 25,0 | 69 |
| SC-5MZ | 12,0 | 6,0 | 25,0 | 65 |
| SC-5M | 12,7 | 6,0 | 25,0 | 69 |
| SC-6M | 16,0 | 6,0 | 25,0 | 69 |
| SC-7M | 19,0 | 6,0 | 25,0 | 69 |
| SC-9M | 25,0 | 6,0 | 25,0 | 69 |

| Bestell-Nr Kreuzverzahnung | Bestell-Nr Normalverzahnung | Stk |
|-------------------------------|--------------------------------|-------|
| 258-22053 | 258-22050 | 14,75 |
| 258-22078 | 258-22075 | 14,75 |
| 258-22103 | 258-22100 | 14,75 |
| 258-22128 | 258-22125 | 14,75 |
| 258-21703 | 258-21700 | 14,75 |
| 258-21728 | 258-21725 | 20,25 |
| 258-21753 | 258-21750 | 18,10 |
| 258-21778 | 258-21775 | 19,95 |
| 258-21803 | 258-21800 | 23,40 |
| 258-29117 | 258-29116 | 19,95 |
| 258-21853 | 258-21850 | 28,50 |
| 258-29121 | 258-29120 | 31,30 |
| 258-21878 | 258-21875 | 31,30 |
| 258-21903 | 258-21900 | 39,35 |
| 258-21953 | 258-21950 | 56,65 |
| 258-22003 | 258-22000 | 85,75 |

VHM-Frässtifte Walzenrundform Langschaftfrässtifte

Schaft Ø 3 mm - Ø 6 mm



| Schaft Ø 3 mm | d ₁ | d ₂ | l ₂ | l ₁ |
|------------------|----------------|----------------|----------------|----------------|
| SC-41ML2 | 3,0 | 3,0 | 14,0 | 50 |
| SC-41ML3 | 3,0 | 3,0 | 14,0 | 75 |

| Bestell-Nr Kreuzverzahnung | Bestell-Nr Normalverzahnung | Stk |
|-------------------------------|--------------------------------|-------|
| 258-27453 | 258-27450 | 10,60 |
| 258-27478 | 258-27475 | 12,00 |

| Schaft Ø 6 mm | d ₁ | d ₂ | l ₂ | l ₁ |
|------------------|----------------|----------------|----------------|----------------|
| SC-1ML6 | 6,0 | 6,0 | 12,7 | 162 |
| SC-3ML6 | 9,5 | 6,0 | 19,0 | 169 |
| SC-5ML6 | 12,7 | 6,0 | 25,0 | 175 |

| Bestell-Nr Kreuzverzahnung | Bestell-Nr Normalverzahnung | Stk |
|-------------------------------|--------------------------------|-------|
| 258-26328 | 258-26325 | 20,60 |
| 258-26353 | 258-26350 | 27,85 |
| 258-26378 | 258-26375 | 41,65 |

VHM-Frässtifte Walzenrundform - Aluminiumverzahnung

Schaft Ø 6 mm

| Schaft Ø 6 mm | d ₁ | d ₂ | l ₂ | l ₁ |
|------------------|----------------|----------------|----------------|----------------|
| SC-1MNF | 6,0 | 6,0 | 19,0 | 50 |
| SC-3MNF | 9,5 | 6,0 | 19,0 | 63 |
| SC-5MNF | 12,7 | 6,0 | 25,0 | 69 |
| SC-7MNF | 19,0 | 6,0 | 25,0 | 69 |

| Bestell-Nr Aluverzahnung | Stk |
|-----------------------------|-------|
| 258-29024 | 19,35 |
| 258-29026 | 25,90 |
| 258-29028 | 37,95 |
| 258-29032 | 79,50 |



VHM-Frässtifte Kugelform (SD)

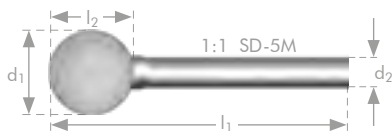

| Schaft Ø 3 mm | d ₁ | d ₂ | l ₂ | l ₁ |
|------------------|----------------|----------------|----------------|----------------|
| SD-41M | 2,5 | 3,0 | 2,3 | 38 |
| SD-42M | 3,0 | 3,0 | 2,5 | 38 |
| SD-52M | 4,0 | 3,0 | 3,4 | 38 |
| SD-53M | 5,0 | 3,0 | 4,7 | 38 |
| SD-51M | 6,3 | 3,0 | 5,0 | 44 |



| Bestell-Nr Kreuzverzahnung | Bestell-Nr Normalverzahnung | Stk |
|-------------------------------|--------------------------------|-------|
| 258-22778 | 258-22775 | 7,65 |
| 258-22803 | 258-22800 | 7,65 |
| 258-22840 | 258-22837 | 18,45 |
| 258-22853 | 258-22850 | 18,45 |
| 258-22828 | 258-22825 | 12,55 |

| Schaft Ø 6 mm | d ₁ | d ₂ | l ₂ | l ₁ |
|------------------|----------------|----------------|----------------|----------------|
| SD-11M | 3,0 | 6,0 | 2,5 | 56 |
| SD-14M | 5,0 | 6,0 | 4,0 | 46 |
| SD-1M | 6,0 | 6,0 | 4,7 | 50 |
| SD-2M | 8,0 | 6,0 | 6,0 | 50 |
| SD-3M | 9,5 | 6,0 | 8,0 | 50 |
| SD-3MZ | 10,0 | 6,0 | 9,0 | 52 |
| SD-4M | 11,0 | 6,0 | 9,5 | 54 |
| SD-5MZ | 12,0 | 6,0 | 10,8 | 54 |
| SD-5M | 12,7 | 6,0 | 11,0 | 51 |
| SD-6M | 16,0 | 6,0 | 14,0 | 55 |
| SD-7M | 19,0 | 6,0 | 16,0 | 62 |
| SD-9M | 25,0 | 6,0 | 21,0 | 72 |

| Bestell-Nr Kreuzverzahnung | Bestell-Nr Normalverzahnung | Stk |
|-------------------------------|--------------------------------|-------|
| 258-22728 | 258-22725 | 13,60 |
| 258-22753 | 258-22750 | 13,60 |
| 258-22453 | 258-22450 | 13,60 |
| 258-22478 | 258-22475 | 14,60 |
| 258-22503 | 258-22500 | 16,40 |
| 258-29125 | 258-29124 | 16,40 |
| 258-22528 | 258-22525 | 18,80 |
| 258-29129 | 258-29128 | 22,05 |
| 258-22553 | 258-22550 | 22,05 |
| 258-22578 | 258-22575 | 27,35 |
| 258-22628 | 258-22625 | 37,70 |
| 258-22678 | 258-22675 | 64,85 |

VHM-Frässtifte Kugelform Langschaftfrässtifte

Schaft Ø 3 mm - Ø 6 mm



| Schaft Ø 3 mm | d ₁ | d ₂ | l ₂ | l ₁ |
|------------------|----------------|----------------|----------------|----------------|
| SD-42ML2 | 3,0 | 3,0 | 2,5 | 50 |
| SD-42ML3 | 3,0 | 3,0 | 2,5 | 75 |

| Bestell-Nr Kreuzverzahnung | Bestell-Nr Normalverzahnung | Stk |
|-------------------------------|--------------------------------|-------|
| 258-27553 | 258-27550 | 10,60 |
| 258-27578 | 258-27575 | 12,00 |

| Schaft Ø 6 mm | d ₁ | d ₂ | l ₂ | l ₁ |
|------------------|----------------|----------------|----------------|----------------|
| SD-1ML6 | 6,0 | 6,0 | 5,0 | 155 |
| SD-3ML6 | 9,5 | 6,0 | 8,0 | 158 |
| SD-5ML6 | 12,7 | 6,0 | 11,0 | 161 |

| Bestell-Nr Kreuzverzahnung | Bestell-Nr Normalverzahnung | Stk |
|-------------------------------|--------------------------------|-------|
| 258-26403 | 258-26400 | 19,10 |
| 258-26428 | 258-26425 | 22,95 |
| 258-26453 | 258-26450 | 30,90 |

VHM-Frässtifte Kugelform - Aluminiumverzahnung

Schaft Ø 6 mm

| Schaft Ø 6 mm | d ₁ | d ₂ | l ₂ | l ₁ |
|------------------|----------------|----------------|----------------|----------------|
| SD-1MNF | 6,0 | 6,0 | 5,0 | 50 |
| SD-3MNF | 9,5 | 6,0 | 8,0 | 52 |
| SD-5MNF | 12,7 | 6,0 | 11,0 | 55 |
| SD-6MNF | 16,0 | 6,0 | 14,0 | 58 |
| SD-7MNF | 19,0 | 6,0 | 16,0 | 62 |

| Bestell-Nr Aluverzahnung | Stk |
|-----------------------------|-------|
| 258-29036 | 19,10 |
| 258-29038 | 21,35 |
| 258-29040 | 37,95 |
| 258-29042 | 55,20 |
| 258-29044 | 79,50 |



VHM-Frässtifte Tropfenform (SE)

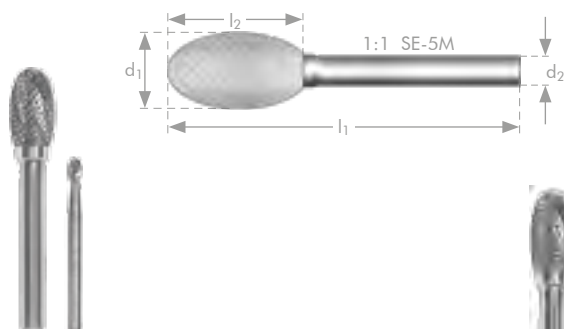

| Schaft Ø 3 mm | d ₁ | d ₂ | l ₂ | l ₁ |
|------------------|----------------|----------------|----------------|----------------|
| SE-41M | 3,0 | 3,0 | 5,5 | 38 |
| SE-53M | 5,0 | 3,0 | 7,1 | 38 |
| SE-51M | 6,3 | 3,0 | 9,5 | 47 |

| Bestell-Nr Kreuzverzahnung | Bestell-Nr Normalverzahnung | Stk |
|-------------------------------|--------------------------------|-------|
| 258-23153 | 258-23150 | 7,65 |
| 258-23203 | 258-23200 | 18,45 |
| 258-23178 | 258-23175 | 12,55 |

| Schaft Ø 6 mm | d ₁ | d ₂ | l ₂ | l ₁ |
|------------------|----------------|----------------|----------------|----------------|
| SE-1M | 6,0 | 6,0 | 9,5 | 50 |
| SE-3M | 9,5 | 6,0 | 16,0 | 60 |
| SE-5M | 12,7 | 6,0 | 22,0 | 66 |
| SE-6M | 16,0 | 6,0 | 25,0 | 69 |
| SE-7M | 19,0 | 6,0 | 25,0 | 69 |

| Bestell-Nr Kreuzverzahnung | Bestell-Nr Normalverzahnung | Stk |
|-------------------------------|--------------------------------|-------|
| 258-22953 | 258-22950 | 16,65 |
| 258-22978 | 258-22975 | 19,95 |
| 258-23003 | 258-23000 | 29,20 |
| 258-23028 | 258-23025 | 40,55 |
| 258-23078 | 258-23075 | 54,45 |

VHM-Frässtifte Tropfenform Langschaftfrässtifte

Schaft Ø 3 mm - Ø 6 mm



| Schaft Ø 3 mm | d ₁ | d ₂ | l ₂ | l ₁ |
|------------------|----------------|----------------|----------------|----------------|
| SE-41ML2 | 3,0 | 3,0 | 5,5 | 50 |
| SE-41ML3 | 3,0 | 3,0 | 5,5 | 75 |

| Bestell-Nr Kreuzverzahnung | Bestell-Nr Normalverzahnung | Stk |
|-------------------------------|--------------------------------|-------|
| 258-27603 | 258-27600 | 10,60 |
| 258-27628 | 258-27625 | 12,00 |

| Schaft Ø 6 mm | d ₁ | d ₂ | l ₂ | l ₁ |
|------------------|----------------|----------------|----------------|----------------|
| SE-1ML6 | 6,0 | 6,0 | 9,5 | 160 |
| SE-3ML6 | 9,5 | 6,0 | 16,0 | 166 |
| SE-5ML6 | 12,7 | 6,0 | 22,0 | 172 |

| Bestell-Nr Kreuzverzahnung | Bestell-Nr Normalverzahnung | Stk |
|-------------------------------|--------------------------------|-------|
| 258-26478 | 258-26475 | 23,25 |
| 258-26503 | 258-26500 | 27,85 |
| 258-26528 | 258-26525 | 40,85 |

VHM-Frässtifte Tropfenform- Aluminiumverzahnung

Schaft Ø 6 mm

| Schaft Ø 6 mm | d ₁ | d ₂ | l ₂ | l ₁ |
|------------------|----------------|----------------|----------------|----------------|
| SE-3MNF | 9,5 | 6,0 | 16,0 | 60 |
| SE-5MNF | 12,7 | 6,0 | 22,0 | 66 |
| SE-6MNF | 16,0 | 6,0 | 25,0 | 69 |
| SE-7MNF | 19,0 | 6,0 | 25,0 | 69 |

| Bestell-Nr Aluverzahnung | Stk |
|-----------------------------|-------|
| 258-29048 | 28,05 |
| 258-29050 | 34,60 |
| 258-29052 | 62,20 |
| 258-29054 | 82,95 |



VHM-Frässtifte Rundbogenform (SF)

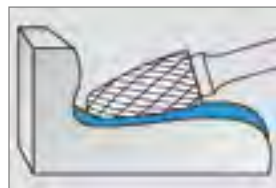
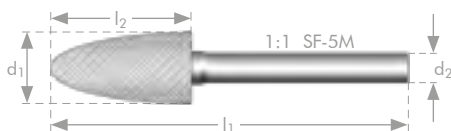

| Schaft Ø 3 mm | d ₁ | d ₂ | l ₂ | l ₁ |
|------------------|----------------|----------------|----------------|----------------|
| SF-41M | 3,0 | 3,0 | 6,0 | 38 |
| SF-42M | 3,0 | 3,0 | 12,7 | 38 |
| SF-53M | 5,0 | 3,0 | 12,7 | 38 |
| SF-51M | 6,3 | 3,0 | 12,7 | 50 |

| Bestell-Nr Kreuzverzahnung | Bestell-Nr Normalverzahnung | Stk |
|-------------------------------|--------------------------------|-------|
| 258-23678 | 258-23675 | 7,65 |
| 258-23703 | 258-23700 | 7,65 |
| 258-23753 | 258-23750 | 18,45 |
| 258-23728 | 258-23725 | 12,55 |

| Schaft Ø 6 mm | d ₁ | d ₂ | l ₂ | l ₁ |
|------------------|----------------|----------------|----------------|----------------|
| SF-11M | 3,0 | 6,0 | 12,7 | 56 |
| SF-1M | 6,0 | 6,0 | 16,0 | 50 |
| SF-3M | 9,5 | 6,0 | 19,0 | 63 |
| SF-4M | 11,0 | 6,0 | 25,0 | 69 |
| SF-5MZ | 12,0 | 6,0 | 25,0 | 65 |
| SF-13M | 12,7 | 6,0 | 19,0 | 63 |
| SF-5M | 12,7 | 6,0 | 25,0 | 69 |
| SF-6M | 16,0 | 6,0 | 25,0 | 69 |
| SF-7M | 19,0 | 6,0 | 25,0 | 69 |
| SF-14M | 19,0 | 6,0 | 32,0 | 76 |
| SF-15M | 19,0 | 6,0 | 38,0 | 82 |

| Bestell-Nr Kreuzverzahnung | Bestell-Nr Normalverzahnung | Stk |
|-------------------------------|--------------------------------|-------|
| 258-23503 | 258-23500 | 15,45 |
| 258-23303 | 258-23300 | 15,45 |
| 258-23328 | 258-23325 | 19,45 |
| 258-23353 | 258-23350 | 27,05 |
| 258-23522 | 258-23520 | 28,80 |
| 258-23528 | 258-23525 | 28,80 |
| 258-23378 | 258-23375 | 28,80 |
| 258-23403 | 258-23400 | 39,80 |
| 258-23453 | 258-23450 | 52,40 |
| 258-23578 | 258-23575 | 65,90 |
| 258-23628 | 258-23625 | 77,40 |

VHM-Frässtifte Rundbogenform Langschaftfrässtifte

Schaft Ø 3 mm - Ø 6 mm



| Schaft Ø 3 mm | d ₁ | d ₂ | l ₂ | l ₁ |
|------------------|----------------|----------------|----------------|----------------|
| SF-41ML2 | 3,0 | 3,0 | 14,0 | 50 |
| SF-41ML3 | 3,0 | 3,0 | 14,0 | 75 |

| Bestell-Nr Kreuzverzahnung | Bestell-Nr Normalverzahnung | Stk |
|-------------------------------|--------------------------------|-------|
| 258-27653 | 258-27650 | 10,60 |
| 258-27678 | 258-27675 | 12,00 |

| Schaft Ø 6 mm | d ₁ | d ₂ | l ₂ | l ₁ |
|------------------|----------------|----------------|----------------|----------------|
| SF-1ML6 | 6,0 | 6,0 | 12,7 | 162 |
| SF-3ML6 | 9,5 | 6,0 | 19,0 | 169 |
| SF-5ML6 | 12,7 | 6,0 | 25,0 | 175 |

| Bestell-Nr Kreuzverzahnung | Bestell-Nr Normalverzahnung | Stk |
|-------------------------------|--------------------------------|-------|
| 258-26553 | 258-26550 | 21,60 |
| 258-26578 | 258-26575 | 27,35 |
| 258-26603 | 258-26600 | 40,20 |

VHM-Frässtifte Rundbogenform- Aluminiumverzahnung

Schaft Ø 6 mm

| Schaft Ø 6 mm | d ₁ | d ₂ | l ₂ | l ₁ |
|------------------|----------------|----------------|----------------|----------------|
| SF-1MNF | 6,0 | 6,0 | 19,0 | 50 |
| SF-3MNF | 9,5 | 6,0 | 19,0 | 63 |
| SF-5MNF | 12,7 | 6,0 | 25,0 | 69 |
| SF-6MNF | 16,0 | 6,0 | 25,0 | 69 |
| SF-14MNF | 19,0 | 6,0 | 32,0 | 76 |

| Bestell-Nr Aluverzahnung | Stk |
|-----------------------------|-------|
| 258-29058 | 19,35 |
| 258-29060 | 27,45 |
| 258-29062 | 38,50 |
| 258-29064 | 55,20 |
| 258-29066 | 76,10 |



VHM-Frässtifte Spitzbogenform (SG)

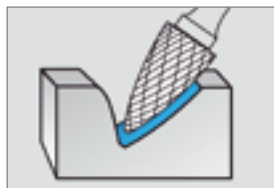
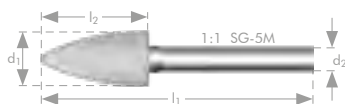

| Schaft Ø 3 mm | d ₁ | d ₂ | l ₂ | l ₁ |
|------------------|----------------|----------------|----------------|----------------|
| SG-41M | 3,0 | 3,0 | 6,0 | 38 |
| SG-43M | 3,0 | 3,0 | 9,5 | 38 |
| SG-44M | 3,0 | 3,0 | 12,7 | 38 |
| SG-53M | 5,0 | 3,0 | 12,7 | 38 |
| SG-51M | 6,3 | 3,0 | 12,7 | 50 |

| Bestell-Nr Kreuzverzahnung | Bestell-Nr Normalverzahnung | Stk |
|-------------------------------|--------------------------------|-------|
| 258-24153 | 258-24150 | 7,65 |
| 258-24203 | 258-24200 | 7,65 |
| 258-24228 | 258-24225 | 7,65 |
| 258-24278 | 258-24275 | 18,45 |
| 258-24253 | 258-24250 | 12,55 |

| Schaft Ø 6 mm | d ₁ | d ₂ | l ₂ | l ₁ |
|------------------|----------------|----------------|----------------|----------------|
| SG-1M | 6,0 | 6,0 | 16,0 | 50 |
| SG-2M | 8,0 | 6,0 | 19,0 | 63 |
| SG-3M | 9,5 | 6,0 | 19,0 | 63 |
| SG-3MZ | 10,0 | 6,0 | 20,0 | 60 |
| SG-5MZ | 12,0 | 6,0 | 25,0 | 65 |
| SG-13M | 12,7 | 6,0 | 19,0 | 63 |
| SG-5M | 12,7 | 6,0 | 25,0 | 69 |
| SG-6M | 16,0 | 6,0 | 25,0 | 69 |
| SG-7M | 19,0 | 6,0 | 25,0 | 69 |
| SG-15M | 19,0 | 6,0 | 38,0 | 82 |

| Bestell-Nr Kreuzverzahnung | Bestell-Nr Normalverzahnung | Stk |
|-------------------------------|--------------------------------|-------|
| 258-23853 | 258-23850 | 15,45 |
| 258-23878 | 258-23875 | 18,80 |
| 258-23903 | 258-23900 | 20,75 |
| 258-24042 | 258-24040 | 20,75 |
| 258-24046 | 258-24045 | 28,30 |
| 258-24053 | 258-24050 | 28,30 |
| 258-23928 | 258-23925 | 28,30 |
| 258-23953 | 258-23950 | 39,30 |
| 258-24003 | 258-24000 | 52,40 |
| 258-24103 | 258-24100 | 77,40 |

VHM-Frässtifte Spitzbogenform
Langschaftfrässtifte, Schaft Ø 3 mm - Ø 6 mm

| Schaft Ø 3 mm | d ₁ | d ₂ | l ₂ | l ₁ |
|------------------|----------------|----------------|----------------|----------------|
| SG-44ML2 | 3,0 | 3,0 | 14,0 | 50 |
| SG-44ML3 | 3,0 | 3,0 | 14,0 | 75 |

| Bestell-Nr Kreuzverzahnung | Bestell-Nr Normalverzahnung | Stk |
|-------------------------------|--------------------------------|-------|
| 258-27853 | 258-27850 | 10,60 |
| 258-27878 | 258-27875 | 12,00 |

| Schaft Ø 6 mm | d ₁ | d ₂ | l ₂ | l ₁ |
|------------------|----------------|----------------|----------------|----------------|
| SG-1-ML6 | 6,0 | 6,0 | 12,7 | 162 |
| SG-3-ML6 | 9,5 | 6,0 | 19,0 | 169 |
| SG-5-ML6 | 12,7 | 6,0 | 25,0 | 175 |

| Bestell-Nr Kreuzverzahnung | Bestell-Nr Normalverzahnung | Stk |
|-------------------------------|--------------------------------|-------|
| 258-26628 | 258-26625 | 21,60 |
| 258-26653 | 258-26650 | 29,05 |
| 258-26678 | 258-26675 | 39,70 |

VHM-Frässtifte Flammenform (SH)

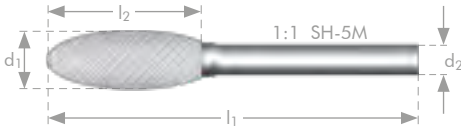

| Schaft Ø 3 mm | d ₁ | d ₂ | l ₂ | l ₁ |
|------------------|----------------|----------------|----------------|----------------|
| SH-41M | 3,0 | 3,0 | 6,3 | 38 |
| SH-53M | 5,0 | 3,0 | 9,5 | 38 |

| Schaft Ø 6 mm | d ₁ | d ₂ | l ₂ | l ₁ |
|------------------|----------------|----------------|----------------|----------------|
| SH-2M | 8,0 | 6,0 | 19,0 | 63 |
| SH-5M | 12,7 | 6,0 | 32,0 | 76 |
| SH-6M | 16,0 | 6,0 | 36,0 | 80 |
| SH-7M | 19,0 | 6,0 | 41,0 | 85 |

| Bestell-Nr Kreuzverzahnung | Bestell-Nr Normalverzahnung | Stk |
|-------------------------------|--------------------------------|-------|
| 258-24553 | 258-24550 | 7,65 |
| 258-24603 | 258-24600 | 18,45 |

| Bestell-Nr Kreuzverzahnung | Bestell-Nr Normalverzahnung | Stk |
|-------------------------------|--------------------------------|-------|
| 258-24403 | 258-24400 | 20,45 |
| 258-24428 | 258-24425 | 41,70 |
| 258-24453 | 258-24450 | 57,60 |
| 258-24503 | 258-24500 | 73,25 |

VHM-Frässtifte Flammenform
Langschaftfrässtifte

Schaft Ø 3 mm - Ø 6 mm

| Schaft Ø 3 mm | d ₁ | d ₂ | l ₂ | l ₁ |
|------------------|----------------|----------------|----------------|----------------|
| SH-41ML2 | 3,0 | 3,0 | 6,3 | 50 |
| SH-41ML3 | 3,0 | 3,0 | 6,6 | 75 |

| Schaft Ø 6 mm | d ₁ | d ₂ | l ₂ | l ₁ |
|------------------|----------------|----------------|----------------|----------------|
| SH-2ML6 | 8,0 | 6,0 | 19,0 | 169 |
| SH-5ML6 | 12,7 | 6,0 | 32,0 | 182 |

| Bestell-Nr Kreuzverzahnung | Bestell-Nr Normalverzahnung | Stk |
|-------------------------------|--------------------------------|-------|
| 258-27903 | 258-27900 | 10,60 |
| 258-27928 | 258-27925 | 12,00 |

| Bestell-Nr Kreuzverzahnung | Bestell-Nr Normalverzahnung | Stk |
|-------------------------------|--------------------------------|-------|
| 258-26703 | 258-26700 | 28,70 |
| 258-26728 | 258-26725 | 58,40 |

VHM-Frässtifte Kegelsenkform 60° (SJ)

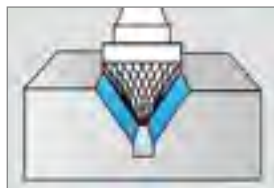
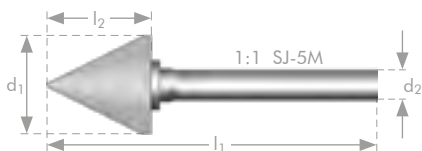

| Schaft Ø 3 mm | d ₁ | d ₂ | l ₂ | l ₁ |
|------------------|----------------|----------------|----------------|----------------|
| SJ-42M | 3,0 | 3,0 | 2,5 | 38 |



| Bestell-Nr Kreuzverzahnung | Bestell-Nr Normalverzahnung | Stk |
|-------------------------------|--------------------------------|------|
| 258-24903 | 258-24900 | 7,65 |

| | | | | |
|--------|-----|-----|-----|----|
| SJ-42M | 5,0 | 3,0 | 4,3 | 37 |
| SJ-42M | 3,0 | 3,0 | 2,6 | 38 |

| Bestell-Nr Feinverzahnung | Stk |
|------------------------------|-------|
| 258-24905 | 29,20 |
| 258-24907 | 17,85 |

| Schaft Ø 6 mm | d ₁ | d ₂ | l ₂ | l ₁ |
|------------------|----------------|----------------|----------------|----------------|
| SJ-1M | 6,0 | 6,0 | 4,0 | 50 |
| SJ-3M | 9,5 | 6,0 | 8,0 | 55 |
| SJ-5M | 12,7 | 6,0 | 11,0 | 58 |
| SJ-6M | 16,0 | 6,0 | 14,5 | 61 |
| SJ-7M | 19,0 | 6,0 | 17,5 | 65 |
| SJ-9M | 25,0 | 6,0 | 24,5 | 68 |

| Bestell-Nr Kreuzverzahnung | Bestell-Nr Normalverzahnung | Stk |
|-------------------------------|--------------------------------|-------|
| 258-24678 | 258-24675 | 13,60 |
| 258-24703 | 258-24700 | 17,80 |
| 258-24728 | 258-24725 | 21,60 |
| 258-24753 | 258-24750 | 28,80 |
| 258-24803 | 258-24800 | 37,85 |
| 258-24853 | 258-24850 | 60,70 |

VHM-Frässtifte Kegelsenkform 90° (SK)

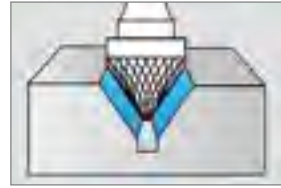
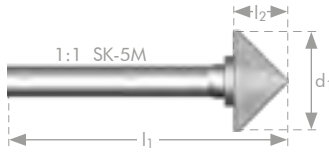

| Schaft Ø 3 mm | d ₁ | d ₂ | l ₂ | l ₁ |
|------------------|----------------|----------------|----------------|----------------|
| SK-42M | 3,0 | 3,0 | 1,5 | 38 |



| Bestell-Nr Kreuzverzahnung | Bestell-Nr Normalverzahnung | Stk |
|-------------------------------|--------------------------------|------|
| 258-25153 | 258-25150 | 7,65 |

| Bestell-Nr Feinverzahnung | Stk |
|------------------------------|-------|
| 258-25155 | 27,75 |
| 258-25157 | 31,40 |

| | | | | |
|--------|-----|-----|-----|----|
| SK-42M | 5,0 | 3,0 | 2,5 | 35 |
| SK-42M | 6,0 | 3,0 | 3,0 | 36 |

| Schaft Ø 6 mm | d ₁ | d ₂ | l ₂ | l ₁ |
|------------------|----------------|----------------|----------------|----------------|
| SK-1M | 6,0 | 6,0 | 3,0 | 50 |
| SK-3M | 9,5 | 6,0 | 4,7 | 52 |
| SK-5M | 12,7 | 6,0 | 6,3 | 54 |
| SK-6M | 16,0 | 6,0 | 8,0 | 57 |
| SK-7M | 19,0 | 6,0 | 9,5 | 58 |
| SK-9M | 25,0 | 6,0 | 12,7 | 60 |

| Bestell-Nr Kreuzverzahnung | Bestell-Nr Normalverzahnung | Stk |
|-------------------------------|--------------------------------|-------|
| 258-24928 | 258-24925 | 13,60 |
| 258-24953 | 258-24950 | 17,80 |
| 258-24978 | 258-24975 | 21,60 |
| 258-25003 | 258-25000 | 28,80 |
| 258-25053 | 258-25050 | 37,85 |
| 258-25103 | 258-25100 | 60,70 |

VHM-Frässtifte Rundkegelform (SL)

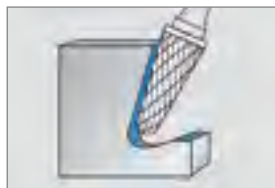
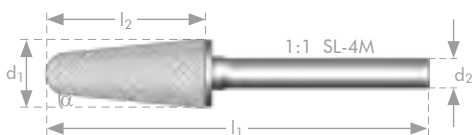

| Schaft Ø 3 mm | d ₁ | d ₂ | l ₂ | l ₁ | α |
|------------------|----------------|----------------|----------------|----------------|-----|
| SL-41M | 3,0 | 3,0 | 9,0 | 38 | 8° |
| SL-42M | 3,0 | 3,0 | 12,7 | 38 | 8° |
| SL-53M | 5,0 | 3,0 | 12,7 | 38 | 14° |

| Bestell-Nr Kreuzverzahnung | Bestell-Nr Normalverzahnung | Stk |
|-------------------------------|--------------------------------|-------|
| 258-25403 | 258-25400 | 7,65 |
| 258-25428 | 258-25425 | 7,65 |
| 258-25453 | 258-25450 | 18,45 |

| Schaft Ø 6 mm | d ₁ | d ₂ | l ₂ | l ₁ | α |
|------------------|----------------|----------------|----------------|----------------|-----|
| SL-1M | 6,0 | 6,0 | 16,0 | 50 | 14° |
| SL-2M | 8,0 | 6,0 | 22,0 | 69 | 14° |
| SL-3M | 9,5 | 6,0 | 27,0 | 74 | 14° |
| SL-4M | 12,7 | 6,0 | 28,0 | 76 | 14° |
| SL-5M | 16,0 | 6,0 | 30,0 | 77 | 14° |
| SL-7M | 19,0 | 6,0 | 38,0 | 85 | 14° |

| Bestell-Nr Kreuzverzahnung | Bestell-Nr Normalverzahnung | Stk |
|-------------------------------|--------------------------------|-------|
| 258-25178 | 258-25175 | 15,80 |
| 258-25203 | 258-25200 | 20,70 |
| 258-25228 | 258-25225 | 24,95 |
| 258-25253 | 258-25250 | 30,45 |
| 258-25278 | 258-25275 | 54,40 |
| 258-25353 | 258-25350 | 79,10 |

VHM-Frässtifte Rundkegelform Langschaftfrässtifte

Schaft Ø 3 mm - Ø 6 mm

| Schaft Ø 3 mm | d ₁ | d ₂ | l ₂ | l ₁ | α |
|------------------|----------------|----------------|----------------|----------------|----|
| SL-42ML2 | 3,0 | 3,0 | 12,7 | 50 | 8° |
| SL-42ML3 | 3,0 | 3,0 | 12,7 | 75 | 8° |

| Schaft Ø 6 mm | d ₁ | d ₂ | l ₂ | l ₁ | α |
|------------------|----------------|----------------|----------------|----------------|-----|
| SL-1ML6 | 6,0 | 6,0 | 16,0 | 166 | 14° |
| SL-3ML6 | 9,5 | 6,0 | 27,0 | 177 | 14° |
| SL-4ML6 | 12,7 | 6,0 | 28,0 | 178 | 14° |



| Bestell-Nr Kreuzverzahnung | Bestell-Nr Normalverzahnung | Stk |
|-------------------------------|--------------------------------|-------|
| 258-27953 | 258-27950 | 10,60 |
| 258-27978 | 258-27975 | 12,00 |

| Bestell-Nr Kreuzverzahnung | Bestell-Nr Normalverzahnung | Stk |
|-------------------------------|--------------------------------|-------|
| 258-26753 | 258-26750 | 22,10 |
| 258-26778 | 258-26775 | 34,90 |
| 258-26803 | 258-26800 | 42,70 |

VHM-Frässtifte Rundkegelform - Aluminiumverzahnung

Schaft Ø 6 mm

| Schaft Ø 6 mm | d ₁ | d ₂ | l ₂ | l ₁ | α |
|------------------|----------------|----------------|----------------|----------------|-----|
| SL-3MNF | 6,0 | 6,0 | 19,0 | 50 | 14° |
| SL-4MNF | 12,7 | 6,0 | 19,0 | 63 | 14° |
| SL-5MNF | 16,0 | 6,0 | 25,0 | 69 | 14° |

| Bestell-Nr Aluverzahnung | Stk |
|-----------------------------|-------|
| 258-29070 | 35,10 |
| 258-29072 | 48,45 |
| 258-29074 | 77,80 |



VHM-Frässtifte Spitzkegelform (SM)

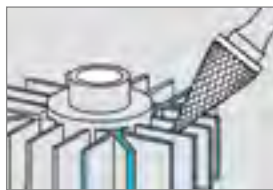
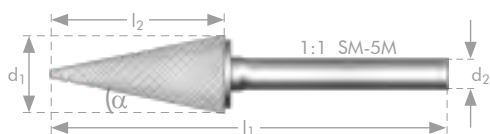

| Schaft Ø 3 mm | d ₁ | d ₂ | l ₂ | l ₁ | α |
|------------------|----------------|----------------|----------------|----------------|-----|
| SM-41M | 3,0 | 3,0 | 8,9 | 38 | 12° |
| SM-42M | 3,0 | 3,0 | 11,0 | 38 | 14° |
| SM-43M | 3,0 | 3,0 | 16,0 | 38 | 7° |
| SM-53M | 5,0 | 3,0 | 12,7 | 38 | 16° |
| SM-51M | 6,3 | 3,0 | 12,7 | 54 | 22° |

| Bestell-Nr Kreuzverzahnung | Bestell-Nr Normalverzahnung | Stk |
|-------------------------------|--------------------------------|-------|
| 258-25678 | 258-25675 | 7,65 |
| 258-25703 | 258-25700 | 7,65 |
| 258-25728 | 258-25725 | 7,65 |
| 258-25778 | 258-25775 | 18,45 |
| 258-25753 | 258-25750 | 12,55 |

| Schaft Ø 6 mm | d ₁ | d ₂ | l ₂ | l ₁ | α |
|------------------|----------------|----------------|----------------|----------------|-----|
| SM-1M | 6,0 | 6,0 | 12,7 | 50 | 22° |
| SM-2M | 6,0 | 6,0 | 19,0 | 50 | 14° |
| SM-3M | 6,0 | 6,0 | 25,0 | 50 | 10° |
| SM-4M | 9,5 | 6,0 | 16,0 | 63 | 28° |
| SM-5M | 12,7 | 6,0 | 22,0 | 69 | 28° |
| SM-6M | 16,0 | 6,0 | 25,0 | 73 | 31° |

| Bestell-Nr Kreuzverzahnung | Bestell-Nr Normalverzahnung | Stk |
|-------------------------------|--------------------------------|-------|
| 258-25503 | 258-25500 | 15,00 |
| 258-25528 | 258-25525 | 15,80 |
| 258-25553 | 258-25550 | 16,90 |
| 258-25578 | 258-25575 | 24,95 |
| 258-25603 | 258-25600 | 31,30 |
| 258-25628 | 258-25625 | 41,70 |

VHM-Frässtifte Spitzkegelform
Langschaftfrässtifte

Schaft Ø 3 mm

| Schaft Ø 3 mm | d ₁ | d ₂ | l ₂ | l ₁ | α |
|------------------|----------------|----------------|----------------|----------------|-----|
| SM-42ML2 | 3,0 | 3,0 | 11,0 | 50 | 14° |
| SM-42ML3 | 3,0 | 3,0 | 11,0 | 75 | 14° |

| Bestell-Nr Kreuzverzahnung | Bestell-Nr Normalverzahnung | Stk |
|-------------------------------|--------------------------------|-------|
| 258-28053 | 258-28050 | 10,60 |
| 258-28078 | 258-28075 | 12,00 |

VHM-Frässtifte Winkelform (SN)

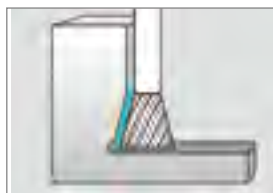
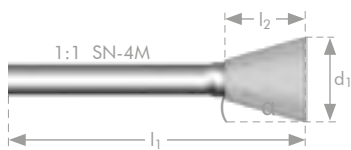

| Schaft Ø 3 mm | d_1 | d_2 | l_2 | l_1 | α |
|------------------|-------|-------|-------|-------|----------|
| SN-41M | 2,5 | 3,0 | 3,0 | 38 | 10° |
| SN-42M | 3,0 | 3,0 | 4,0 | 38 | 10° |
| SN-53M | 5,0 | 3,0 | 6,3 | 38 | 10° |
| SN-51M | 6,3 | 3,0 | 6,0 | 44 | 10° |

| Bestell-Nr Kreuzverzahnung | Bestell-Nr Normalverzahnung | Stk |
|-------------------------------|--------------------------------|-------|
| 258-26028 | 258-26025 | 7,65 |
| 258-26053 | 258-26050 | 7,65 |
| 258-26103 | 258-26100 | 18,45 |
| 258-26078 | 258-26075 | 12,55 |

| Schaft Ø 6 mm | d_1 | d_2 | l_2 | l_1 | α |
|------------------|-------|-------|-------|-------|----------|
| SN-1M | 6,0 | 6,0 | 8,0 | 50 | 10° |
| SN-2M | 9,5 | 6,0 | 9,5 | 53 | 13° |
| SN-4M | 12,7 | 6,0 | 12,7 | 57 | 28° |
| SN-6M | 16,0 | 6,0 | 19,5 | 63 | 18° |
| SN-7M | 19,0 | 6,0 | 16,0 | 60 | 30° |

| Bestell-Nr Kreuzverzahnung | Bestell-Nr Normalverzahnung | Stk |
|-------------------------------|--------------------------------|-------|
| 258-25853 | 258-25850 | 15,10 |
| 258-25878 | 258-25875 | 22,05 |
| 258-25903 | 258-25900 | 31,15 |
| 258-25928 | 258-25925 | 40,00 |
| 258-25978 | 258-25975 | 44,95 |

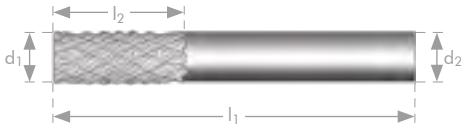

Stirn glatt

| d ₁ | d ₂ | l ₂ | l ₁ | Bestell-Nr unbeschichtet | Stk |
|----------------|----------------|----------------|----------------|-----------------------------|-------|
| 1,6 | 3 | 5 | 38 | 258-83001 | 11,50 |
| 2,4 | 3 | 9,5 | 38 | 258-83002 | 12,25 |
| 3,0 | 3 | 12 | 38 | 258-83003 | 11,70 |
| 4 | 4 | 16 | 50 | 258-83004 | 19,15 |
| 4 | 6 | 16 | 50 | 258-83005 | 20,85 |
| 6 | 6 | 19 | 50 | 258-83006 | 20,85 |
| 6 | 6 | 19 | 63 | 258-83007 | 20,85 |
| 6 | 6 | 25 | 75 | 258-83008 | 25,85 |
| 8 | 8 | 25 | 63 | 258-83009 | 43,30 |
| 10 | 10 | 25 | 75 | 258-83010 | 53,95 |
| 12 | 12 | 25 | 75 | 258-83011 | 74,05 |

Stirn wie Frässtift

| d ₁ | d ₂ | l ₂ | l ₁ | Bestell-Nr unbeschichtet | Stk |
|----------------|----------------|----------------|----------------|-----------------------------|-------|
| 1,6 | 3 | 5 | 38 | 258-83015 | 13,65 |
| 2,4 | 3 | 9,5 | 38 | 258-83016 | 13,65 |
| 3,0 | 3 | 12 | 38 | 258-83017 | 13,05 |
| 4 | 4 | 16 | 50 | 258-83018 | 21,25 |
| 4 | 6 | 16 | 50 | 258-83019 | 23,30 |
| 6 | 6 | 19 | 50 | 258-83020 | 23,30 |
| 6 | 6 | 19 | 63 | 258-83021 | 23,30 |
| 6 | 6 | 25 | 75 | 258-83022 | 28,10 |
| 8 | 8 | 25 | 63 | 258-83023 | 46,15 |
| 10 | 10 | 25 | 75 | 258-83024 | 58,60 |
| 12 | 12 | 25 | 75 | 258-83025 | 81,50 |

Fräserstirn

| d ₁ | d ₂ | l ₂ | l ₁ | Bestell-Nr unbeschichtet | Stk |
|----------------|----------------|----------------|----------------|-----------------------------|-------|
| 1,6 | 3 | 5 | 38 | 258-83030 | 13,75 |
| 2,4 | 3 | 9,5 | 38 | 258-83031 | 14,85 |
| 3,0 | 3 | 12 | 38 | 258-83032 | 14,10 |
| 4 | 4 | 16 | 50 | 258-83033 | 22,15 |
| 4 | 6 | 16 | 50 | 258-83034 | 24,85 |
| 6 | 6 | 19 | 50 | 258-83035 | 24,85 |
| 6 | 6 | 19 | 63 | 258-83036 | 24,85 |
| 6 | 6 | 25 | 75 | 258-83037 | 29,95 |
| 8 | 8 | 25 | 63 | 258-83038 | 47,95 |
| 10 | 10 | 25 | 75 | 258-83039 | 60,90 |
| 12 | 12 | 25 | 75 | 258-83040 | 85,45 |

Bohrerspitze

| d ₁ | d ₂ | l ₂ | l ₁ | Bestell-Nr unbeschichtet | Stk |
|----------------|----------------|----------------|----------------|-----------------------------|-------|
| 1,6 | 3 | 5 | 38 | 258-83045 | 14,55 |
| 2,4 | 3 | 9,5 | 38 | 258-83046 | 15,65 |
| 3,0 | 3 | 12 | 38 | 258-83047 | 14,95 |
| 4 | 4 | 16 | 50 | 258-83048 | 22,30 |
| 4 | 6 | 16 | 50 | 258-83049 | 25,90 |
| 6 | 6 | 19 | 50 | 258-83050 | 25,90 |
| 6 | 6 | 19 | 63 | 258-83051 | 25,90 |
| 6 | 6 | 25 | 75 | 258-83052 | 30,40 |
| 8 | 8 | 25 | 63 | 258-83053 | 49,40 |
| 10 | 10 | 25 | 75 | 258-83054 | 63,25 |
| 12 | 12 | 25 | 75 | 258-83055 | 89,40 |

Schnittwertempfehlung

| Werkstoff GFK | Schneidendurchmesser (mm) | | | |
|-------------------------------|---------------------------|-----------------|-----------------|-----------------|
| | Ø 1,6 | Ø 2,4 | Ø 3 | Ø 4 |
| Drehzahl (min ⁻¹) | 40.000 - 45.000 | 25.000 - 30.000 | 20.000 - 25.000 | 20.000 - 24.000 |
| Vorschub (mm/sec) | 1.000 - 1.500 | 1.100 - 1.800 | 1.100 - 1.800 | 900 - 1.700 |
| | Ø 6 | Ø 10 | Ø 12 | |
| Drehzahl (min ⁻¹) | 20.000 - 24.000 | 15.000 - 20.000 | 10.000 - 15.000 | |
| Vorschub (mm/sec) | 900 - 1.700 | 700 - 1.500 | 500 - 1.300 | |