

## Frässtifte VHM-Mini

## VORTEILE

- ▶ Hohe Formgenauigkeit
- ▶ Hohe Rundlaufgenauigkeit, daher große Laufruhe
- ▶ Universalverzahnung
- ▶ Hergestellt aus Feinkornhartmetall
- ▶ Feinst geschliffene Schneiden

## ZU BEARBEITENDE

## WERKSTOFFE

- ▶ Edelstähle
- ▶ Buntmetalle
- ▶ Zinkdruckguss
- ▶ Weiche Keramiken
- ▶ Titanlegierungen

## ANWENDUNGSHINWEISE

- ▶ Möglichst kurz spannen
- ▶ Auf exakten Rundlauf der Spannzange achten
- ▶ Max. Drehzahl: 70.000 min<sup>-1</sup>

## EINSATZGEBIETE

- ▶ Werkzeugbau
- ▶ Feinmechanik
- ▶ Schmuckindustrie
- ▶ Turbinenbau

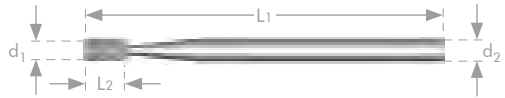

d <sub>1</sub>	d <sub>2</sub>	L <sub>2</sub>	L <sub>1</sub>	Bestell-Nr Universalverzahnung	Stk
1,0	3,0	4,0	40	<b>258-A010-03</b>	15,25
1,5	3,0	4,0	40	<b>258-A015-03</b>	15,25
2,0	3,0	4,0	40	<b>258-A020-03</b>	15,25



1,0	3,0	4,0	40	<b>258-C010-03</b>	15,25
1,5	3,0	4,0	40	<b>258-C015-03</b>	15,25
2,0	3,0	4,0	40	<b>258-C020-03</b>	15,25



1,0	3,0		40	<b>258-D010-03</b>	15,25
1,5	3,0		40	<b>258-D015-03</b>	15,25
2,0	3,0		40	<b>258-D020-03</b>	15,25



1,5	3,0	4,0	40	<b>258-E015-03</b>	15,25
-----	-----	-----	----	--------------------	-------



1,5	3,0	4,0	40	<b>258-F015-03</b>	15,25
-----	-----	-----	----	--------------------	-------



1,5	3,0	4,0	40	<b>258-G015-03</b>	15,25
-----	-----	-----	----	--------------------	-------



1,5	3,0	4,0	40	<b>258-M015-03</b>	15,25
-----	-----	-----	----	--------------------	-------

## Verzahnungsauswahl



**Kreuzverzahnung**  
Sehr gute Spanabnahme, kleine Späne



**Normalverzahnung**  
Sehr gute Spanabnahme, gute Oberfläche



**Aluverzahnung**  
Große Spanräume, gute Schneidwirkung



**Normalverzahnung**  
Mit Spanbrecher  
Ähnlich Normalverzahnung, jedoch kürzere Späne



**Diamantverzahnung**  
Für harte und spröde Werkstoffe



**Grobverzahnung**  
Größere Spanräume für erhöhten Spanabtrag



**Feinverzahnung**  
Für harte und spröde Werkstoffe, gute Oberfläche

Werkstoff	Verzahnung						
	6	3	1	3SP	4	2	5
Aluminium			●				
Messing, Kupfer, Bronze	●	●		●		●	
Kohlefaser						●	
Glasfaser					●		
Gusseisen	●	●		●			
Kunststoff			●			●	
Hartgummi						●	
Stahl > 55 HRC	●	●		●	●		●
Stahl > 60 HRC	●	●		●	●		●
Stahl	●	●		●			
Rostfreier Stahl	●	●		●			●
Nickellegierungen	●	●		●	●		
Schweißteile	●	●		●			
Titan	●	●		●			
Zink			●			●	



## Langschaffrässtifte sind mit reduzierter Drehzahl einzusetzen!

Bei Anwendungen mit schnelllaufenden Werkzeugen ist aus Sicherheitsgründen eine Schutzbrille zu tragen!

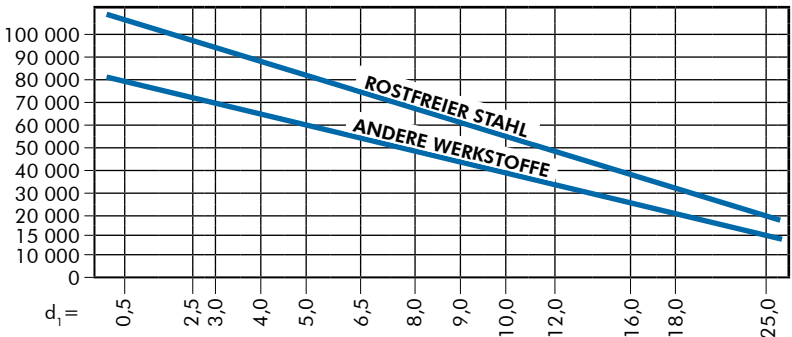

## VHM-Frässtifte Zylinderform (SA)

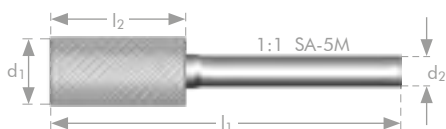
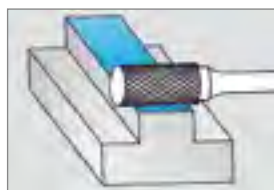

Schaft Ø 3 mm	d <sub>1</sub>	d <sub>2</sub>	l <sub>2</sub>	l <sub>1</sub>
SA-41M	1,5	3,0	6,0	38
SA-42M	2,5	3,0	11,0	38
SA-43M	3,0	3,0	14,0	38
SA-52M	4,0	3,0	12,7	38
SA-53M	5,0	3,0	12,7	38
SA-51M	6,3	3,0	12,7	50

Bestell-Nr Kreuzverzahnung	Bestell-Nr Normalverzahnung	Stk
<b>258-20603</b>	<b>258-20600</b>	7,30
<b>258-20628</b>	<b>258-20625</b>	7,30
<b>258-20653</b>	<b>258-20650</b>	7,30
<b>258-20703</b>	<b>258-20700</b>	17,50
<b>258-20728</b>	<b>258-20725</b>	17,50
<b>258-20678</b>	<b>258-20675</b>	11,95

Schaft Ø 6 mm	d <sub>1</sub>	d <sub>2</sub>	l <sub>2</sub>	l <sub>1</sub>
SA-11M	3,0	6,0	12,0	56
SA-12M	3,0	6,0	12,7	60
SA-13M	4,0	6,0	16,0	50
SA-14M	5,0	6,0	16,0	50
SA-1M	6,0	6,0	16,0	50
SA-1ML	6,0	6,0	25,0	50
SA-2M	8,0	6,0	19,0	63
SA-3M	9,5	6,0	19,0	63
SA-3ML	9,5	6,0	25,0	69
SA-3MZ	10,0	6,0	20,0	60
SA-4M	11,0	6,0	25,0	69
SA-5MZ	12,0	6,0	25,0	65
SA-5M	12,7	6,0	25,0	69
SA-6M	16,0	6,0	25,0	69
SA-7M	19,0	6,0	25,0	69
SA-9M	25,0	6,0	25,0	69

Bestell-Nr Kreuzverzahnung	Bestell-Nr Normalverzahnung	Stk
<b>258-20403</b>	<b>258-20400</b>	12,05
<b>258-20428</b>	<b>258-20425</b>	12,05
<b>258-20453</b>	<b>258-20450</b>	12,05
<b>258-20478</b>	<b>258-20475</b>	12,05
<b>258-20003</b>	<b>258-20000</b>	12,05
<b>258-20028</b>	<b>258-20025</b>	17,50
<b>258-20053</b>	<b>258-20050</b>	15,80
<b>258-20078</b>	<b>258-20075</b>	17,05
<b>258-20103</b>	<b>258-20100</b>	20,25
<b>258-29101</b>	<b>258-29100</b>	17,05
<b>258-20153</b>	<b>258-20150</b>	24,60
<b>258-29105</b>	<b>258-29104</b>	26,55
<b>258-20178</b>	<b>258-20175</b>	26,55
<b>258-20203</b>	<b>258-20200</b>	33,40
<b>258-20253</b>	<b>258-20250</b>	49,75
<b>258-20353</b>	<b>258-20350</b>	69,55

## VHM-Frässtifte Zylinderform Langschaftfrässtifte

Schaft Ø 3 mm - 6 mm



Schaft Ø 3 mm	d <sub>1</sub>	d <sub>2</sub>	l <sub>2</sub>	l <sub>1</sub>
SA-41ML2	1,5	3,0	6,0	50
SA-41ML3	1,5	3,0	6,0	75
SA-42ML2	2,5	3,0	11,0	50
SA-42ML3	2,5	3,0	11,0	75
SA-43ML2	3,0	3,0	14,0	50
SA-43ML3	3,0	3,0	14,0	75

Bestell-Nr Kreuzverzahnung	Bestell-Nr Normalverzahnung	Stk
258-27103	258-27100	10,10
258-27128	258-27125	11,40
258-27153	258-27150	10,10
258-27178	258-27175	11,40
258-27203	258-27200	10,10
258-27228	258-27225	11,40

Schaft Ø 6 mm	d <sub>1</sub>	d <sub>2</sub>	l <sub>2</sub>	l <sub>1</sub>
SA-1ML6	6,0	6,0	12,7	162
SA-3ML6	9,5	6,0	19,0	169
SA-5ML6	12,7	6,0	25,0	175

Bestell-Nr Kreuzverzahnung	Bestell-Nr Normalverzahnung	Stk
258-26178	258-26175	16,90
258-26203	258-26200	23,80
258-26228	258-26225	37,10

## VHM-Frässtifte Zylinderform - Aluminiumverzahnung

Schaft Ø 6 mm

Schaft Ø 6 mm	d <sub>1</sub>	d <sub>2</sub>	l <sub>2</sub>	l <sub>1</sub>
SA-1MNF	6,0	6,0	19,0	50
SA-3MNF	9,5	6,0	19,0	63
SA-5MNF	12,7	6,0	25,0	69
SA-6MNF	16,0	6,0	25,0	69
SA-7MNF	19,0	6,0	25,0	69

Bestell-Nr Aluverzahnung	Stk
258-29000	16,40
258-29002	24,60
258-29004	36,05
258-29006	44,25
258-29008	60,75



## VHM-Frässtifte Zylinderform mit Stirnverzahnung (SB)

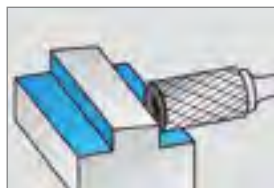
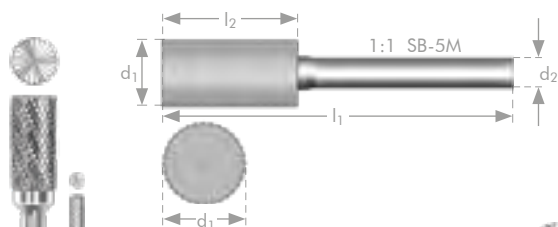

Schaft Ø 3 mm	d <sub>1</sub>	d <sub>2</sub>	l <sub>2</sub>	l <sub>1</sub>
SB-41M	1,5	3,0	6,0	38
SB-42M	2,5	3,0	11,0	38
SB-ECOM	3,0	3,0	0,0	38
SB-43M	3,0	3,0	14,0	38
SB-51M	6,3	3,0	12,7	38

Bestell-Nr Kreuzverzahnung	Bestell-Nr Normalverzahnung	Stk
<b>258-21453</b>	<b>258-21450</b>	7,30
<b>258-21478</b>	<b>258-21475</b>	7,30
-	<b>258-21525</b>	7,30
<b>258-21503</b>	<b>258-21500</b>	7,30
<b>258-21553</b>	<b>258-21550</b>	11,95

Schaft Ø 6 mm	d <sub>1</sub>	d <sub>2</sub>	l <sub>2</sub>	l <sub>1</sub>
SB-11M	3,0	6,0	12,0	56
SB-12M	3,0	6,0	12,7	60
SB-13M	4,0	6,0	16,0	50
SB-14M	5,0	6,0	16,0	50
SB-1M	6,0	6,0	16,0	50
SB-1ML	6,0	6,0	25,0	50
SB-2M	8,0	6,0	19,0	63
SB-3M	9,5	6,0	19,0	63
SB-3ML	9,5	6,0	25,0	69
SB-3MZ	10,0	6,0	20,0	60
SB-4M	11,0	6,0	25,0	69
SB-5MZ	12,0	6,0	25,0	65
SB-5M	12,7	6,0	25,0	69
SB-6M	16,0	6,0	25,0	69
SB-7M	19,0	6,0	25,0	69
SB-9M	25,0	6,0	25,0	69

Bestell-Nr Kreuzverzahnung	Bestell-Nr Normalverzahnung	Stk
<b>258-21253</b>	<b>258-21250</b>	13,15
<b>258-21278</b>	<b>258-21275</b>	13,15
<b>258-21303</b>	<b>258-21300</b>	13,15
<b>258-21328</b>	<b>258-21325</b>	13,15
<b>258-20853</b>	<b>258-20850</b>	13,15
<b>258-20873</b>	<b>258-20870</b>	19,40
<b>258-20903</b>	<b>258-20900</b>	17,40
<b>258-20928</b>	<b>258-20925</b>	18,70
<b>258-20953</b>	<b>258-20950</b>	22,20
<b>258-29109</b>	<b>258-29108</b>	18,70
<b>258-21003</b>	<b>258-21000</b>	27,20
<b>258-29113</b>	<b>258-29112</b>	29,15
<b>258-21028</b>	<b>258-21025</b>	29,15
<b>258-21053</b>	<b>258-21050</b>	36,75
<b>258-21103</b>	<b>258-21100</b>	54,75
<b>258-21203</b>	<b>258-21200</b>	76,60

## VHM-Frässtifte Zylinderform mit Stirnverzahnung

### Langschaftfrässtifte

Schaft Ø 3 mm



Schaft Ø 3 mm	d <sub>1</sub>	d <sub>2</sub>	l <sub>2</sub>	l <sub>1</sub>
SB-41ML2	1,5	3,0	6,0	50
SB-41ML3	1,5	3,0	6,0	75
SB-42ML2	2,5	3,0	11,0	50
SB-42ML3	2,5	3,0	11,0	75
SB-43ML2	3,0	3,0	14,0	50
SB-43ML3	3,0	3,0	14,0	75

Bestell-Nr Kreuzverzahnung	Bestell-Nr Normalverzahnung	Stk
<b>258-27253</b>	<b>258-27250</b>	10,10
<b>258-27278</b>	<b>258-27275</b>	11,40
<b>258-27303</b>	<b>258-27300</b>	10,10
<b>258-27328</b>	<b>258-27325</b>	11,40
<b>258-27353</b>	<b>258-27350</b>	10,10
<b>258-27378</b>	<b>258-27375</b>	12,55

## VHM-Frässtifte Zylinderform mit Stirnverzahnung - Aluminiumverzahnung

Schaft Ø 6 mm

Schaft Ø 6 mm	d <sub>1</sub>	d <sub>2</sub>	l <sub>2</sub>	l <sub>1</sub>
SB-1MNF	6,0	6,0	16,0	50
SB-3MNF	9,5	6,0	19,0	63
SB-5MNF	12,7	6,0	25,0	69
SB-6MNF	16,0	6,0	25,0	69
SB-7MNF	19,0	6,0	25,0	69

Bestell-Nr Aluverzahnung	Stk
<b>258-29012</b>	18,05
<b>258-29014</b>	27,05
<b>258-29016</b>	39,65
<b>258-29018</b>	48,70
<b>258-29020</b>	66,85



## VHM-Frässtifte Walzenrundform (SC)

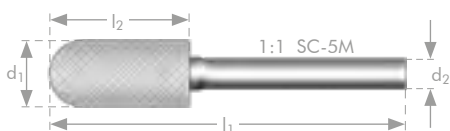

Schaft Ø 3 mm	d <sub>1</sub>	d <sub>2</sub>	l <sub>2</sub>	l <sub>1</sub>
SC-41M	2,5	3,0	11,0	38
SC-42M	3,0	3,0	14,0	38
SC-52M	4,0	3,0	12,7	38
SC-43M	5,0	3,0	14,0	38
SC-51M	6,3	3,0	12,7	38

Bestell-Nr Kreuzverzahnung	Bestell-Nr Normalverzahnung	Stk
<b>258-22253</b>	<b>258-22250</b>	7,30
<b>258-22278</b>	<b>258-22275</b>	7,30
<b>258-22328</b>	<b>258-22325</b>	17,50
<b>258-22353</b>	<b>258-22350</b>	17,50
<b>258-22303</b>	<b>258-22300</b>	11,95

Schaft Ø 6 mm	d <sub>1</sub>	d <sub>2</sub>	l <sub>2</sub>	l <sub>1</sub>
SC-11M	3,0	6,0	12,0	56
SC-12M	3,0	6,0	12,7	60
SC-13M	4,0	6,0	16,0	50
SC-14M	5,0	6,0	16,0	50
SC-1M	6,0	6,0	16,0	50
SC-1ML	6,0	6,0	25,0	50
SC-2M	8,0	6,0	19,0	63
SC-3M	9,5	6,0	19,0	63
SC-3ML	9,5	6,0	25,0	69
SC-3MZ	10,0	6,0	20,0	60
SC-4M	11,0	6,0	25,0	69
SC-5MZ	12,0	6,0	25,0	65
SC-5M	12,7	6,0	25,0	69
SC-6M	16,0	6,0	25,0	69
SC-7M	19,0	6,0	25,0	69
SC-9M	25,0	6,0	25,0	69

Bestell-Nr Kreuzverzahnung	Bestell-Nr Normalverzahnung	Stk
<b>258-22053</b>	<b>258-22050</b>	14,05
<b>258-22078</b>	<b>258-22075</b>	14,05
<b>258-22103</b>	<b>258-22100</b>	14,05
<b>258-22128</b>	<b>258-22125</b>	14,05
<b>258-21703</b>	<b>258-21700</b>	14,05
<b>258-21728</b>	<b>258-21725</b>	19,25
<b>258-21753</b>	<b>258-21750</b>	17,25
<b>258-21778</b>	<b>258-21775</b>	18,95
<b>258-21803</b>	<b>258-21800</b>	22,25
<b>258-29117</b>	<b>258-29116</b>	18,95
<b>258-21853</b>	<b>258-21850</b>	27,05
<b>258-29121</b>	<b>258-29120</b>	29,75
<b>258-21878</b>	<b>258-21875</b>	29,75
<b>258-21903</b>	<b>258-21900</b>	37,40
<b>258-21953</b>	<b>258-21950</b>	53,80
<b>258-22003</b>	<b>258-22000</b>	81,45

## VHM-Frässtifte Walzenrundform Langschaftfrässtifte

Schaft Ø 3 mm - Ø 6 mm



Schaft Ø 3 mm	d <sub>1</sub>	d <sub>2</sub>	l <sub>2</sub>	l <sub>1</sub>
SC-41ML2	3,0	3,0	14,0	50
SC-41ML3	3,0	3,0	14,0	75

Bestell-Nr Kreuzverzahnung	Bestell-Nr Normalverzahnung	Stk
<b>258-27453</b>	<b>258-27450</b>	10,10
<b>258-27478</b>	<b>258-27475</b>	11,40

Schaft Ø 6 mm	d <sub>1</sub>	d <sub>2</sub>	l <sub>2</sub>	l <sub>1</sub>
SC-1ML6	6,0	6,0	12,7	162
SC-3ML6	9,5	6,0	19,0	169
SC-5ML6	12,7	6,0	25,0	175

Bestell-Nr Kreuzverzahnung	Bestell-Nr Normalverzahnung	Stk
<b>258-26328</b>	<b>258-26325</b>	19,60
<b>258-26353</b>	<b>258-26350</b>	26,50
<b>258-26378</b>	<b>258-26375</b>	41,65

## VHM-Frässtifte Walzenrundform - Aluminiumverzahnung

Schaft Ø 6 mm

Schaft Ø 6 mm	d <sub>1</sub>	d <sub>2</sub>	l <sub>2</sub>	l <sub>1</sub>
SC-1MNF	6,0	6,0	19,0	50
SC-3MNF	9,5	6,0	19,0	63
SC-5MNF	12,7	6,0	25,0	69
SC-7MNF	19,0	6,0	25,0	69

Bestell-Nr Aluverzahnung	Stk
<b>258-29024</b>	18,40
<b>258-29026</b>	24,60
<b>258-29028</b>	36,05
<b>258-29032</b>	75,55





## VHM-Frässtifte Kugelform (SD)

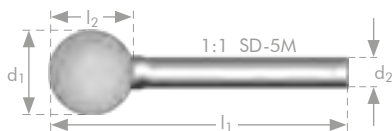

Schaft Ø 3 mm	d <sub>1</sub>	d <sub>2</sub>	l <sub>2</sub>	l <sub>1</sub>
SD-41M	2,5	3,0	2,3	38
SD-42M	3,0	3,0	2,5	38
SD-52M	4,0	3,0	3,4	38
SD-53M	5,0	3,0	4,7	38
SD-51M	6,3	3,0	5,0	44



Bestell-Nr Kreuzverzahnung	Bestell-Nr Normalverzahnung	Stk
258-22778	258-22775	7,30
258-22803	258-22800	7,30
258-22840	258-22837	17,50
258-22853	258-22850	17,50
258-22828	258-22825	11,95



Schaft Ø 6 mm	d <sub>1</sub>	d <sub>2</sub>	l <sub>2</sub>	l <sub>1</sub>
SD-11M	3,0	6,0	2,5	56
SD-14M	5,0	6,0	4,0	46
SD-1M	6,0	6,0	4,7	50
SD-2M	8,0	6,0	6,0	50
SD-3M	9,5	6,0	8,0	50
SD-3MZ	10,0	6,0	9,0	52
SD-4M	11,0	6,0	9,5	54
SD-5MZ	12,0	6,0	10,8	54
SD-5M	12,7	6,0	11,0	51
SD-6M	16,0	6,0	14,0	55
SD-7M	19,0	6,0	16,0	62
SD-9M	25,0	6,0	21,0	72

Bestell-Nr Kreuzverzahnung	Bestell-Nr Normalverzahnung	Stk
258-22728	258-22725	12,95
258-22753	258-22750	12,95
258-22453	258-22450	12,95
258-22478	258-22475	13,85
258-22503	258-22500	15,55
258-29125	258-29124	15,55
258-22528	258-22525	17,95
258-29129	258-29128	20,95
258-22553	258-22550	20,95
258-22578	258-22575	25,95
258-22628	258-22625	35,85
258-22678	258-22675	61,60

## VHM-Frässtifte Kugelform Langschaftfrässtifte

Schaft Ø 3 mm - Ø 6 mm



Schaft Ø 3 mm	d <sub>1</sub>	d <sub>2</sub>	l <sub>2</sub>	l <sub>1</sub>
SD-42ML2	3,0	3,0	2,5	50
SD-42ML3	3,0	3,0	2,5	75

Bestell-Nr Kreuzverzahnung	Bestell-Nr Normalverzahnung	Stk
<b>258-27553</b>	<b>258-27550</b>	10,10
<b>258-27578</b>	<b>258-27575</b>	11,40

Schaft Ø 6 mm	d <sub>1</sub>	d <sub>2</sub>	l <sub>2</sub>	l <sub>1</sub>
SD-1ML6	6,0	6,0	5,0	155
SD-3ML6	9,5	6,0	8,0	158
SD-5ML6	12,7	6,0	11,0	161

Bestell-Nr Kreuzverzahnung	Bestell-Nr Normalverzahnung	Stk
<b>258-26403</b>	<b>258-26400</b>	18,10
<b>258-26428</b>	<b>258-26425</b>	21,80
<b>258-26453</b>	<b>258-26450</b>	29,35

## VHM-Frässtifte Kugelform - Aluminiumverzahnung

Schaft Ø 6 mm

Schaft Ø 6 mm	d <sub>1</sub>	d <sub>2</sub>	l <sub>2</sub>	l <sub>1</sub>
SD-1MNF	6,0	6,0	5,0	50
SD-3MNF	9,5	6,0	8,0	52
SD-5MNF	12,7	6,0	11,0	55
SD-6MNF	16,0	6,0	14,0	58
SD-7MNF	19,0	6,0	16,0	62

Bestell-Nr Aluverzahnung	Stk
<b>258-29036</b>	18,10
<b>258-29038</b>	20,25
<b>258-29040</b>	36,05
<b>258-29042</b>	52,45
<b>258-29044</b>	75,55



## VHM-Frässtifte Tropfenform (SE)

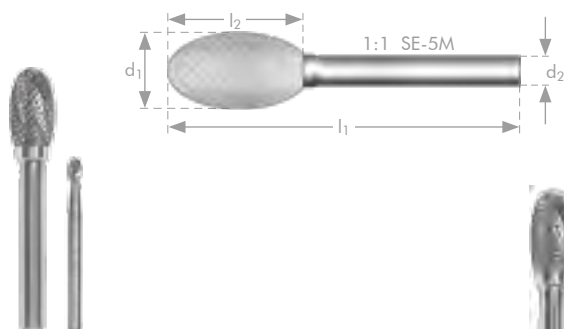

Schaft Ø 3 mm	d <sub>1</sub>	d <sub>2</sub>	l <sub>2</sub>	l <sub>1</sub>
SE-41M	3,0	3,0	5,5	38
SE-53M	5,0	3,0	7,1	38
SE-51M	6,3	3,0	9,5	47

Bestell-Nr Kreuzverzahnung	Bestell-Nr Normalverzahnung	Stk
<b>258-23153</b>	<b>258-23150</b>	7,30
<b>258-23203</b>	<b>258-23200</b>	17,50
<b>258-23178</b>	<b>258-23175</b>	11,95

Schaft Ø 6 mm	d <sub>1</sub>	d <sub>2</sub>	l <sub>2</sub>	l <sub>1</sub>
SE-1M	6,0	6,0	9,5	50
SE-3M	9,5	6,0	16,0	60
SE-5M	12,7	6,0	22,0	66
SE-6M	16,0	6,0	25,0	69
SE-7M	19,0	6,0	25,0	69

Bestell-Nr Kreuzverzahnung	Bestell-Nr Normalverzahnung	Stk
<b>258-22953</b>	<b>258-22950</b>	15,80
<b>258-22978</b>	<b>258-22975</b>	18,95
<b>258-23003</b>	<b>258-23000</b>	27,70
<b>258-23028</b>	<b>258-23025</b>	38,50
<b>258-23078</b>	<b>258-23075</b>	51,75

## VHM-Frässtifte Tropfenform Langschaftfrässtifte

Schaft Ø 3 mm - Ø 6 mm



Schaft Ø 3 mm	d <sub>1</sub>	d <sub>2</sub>	l <sub>2</sub>	l <sub>1</sub>
SE-41ML2	3,0	3,0	5,5	50
SE-41ML3	3,0	3,0	5,5	75

Bestell-Nr Kreuzverzahnung	Bestell-Nr Normalverzahnung	Stk
<b>258-27603</b>	<b>258-27600</b>	10,10
<b>258-27628</b>	<b>258-27625</b>	11,40

Schaft Ø 6 mm	d <sub>1</sub>	d <sub>2</sub>	l <sub>2</sub>	l <sub>1</sub>
SE-1ML6	6,0	6,0	9,5	160
SE-3ML6	9,5	6,0	16,0	166
SE-5ML6	12,7	6,0	22,0	172

Bestell-Nr Kreuzverzahnung	Bestell-Nr Normalverzahnung	Stk
<b>258-26478</b>	<b>258-26475</b>	22,10
<b>258-26503</b>	<b>258-26500</b>	26,50
<b>258-26528</b>	<b>258-26525</b>	38,80

## VHM-Frässtifte Tropfenform- Aluminiumverzahnung

Schaft Ø 6 mm

Schaft Ø 6 mm	d <sub>1</sub>	d <sub>2</sub>	l <sub>2</sub>	l <sub>1</sub>
SE-3MNF	9,5	6,0	16,0	60
SE-5MNF	12,7	6,0	22,0	66
SE-6MNF	16,0	6,0	25,0	69
SE-7MNF	19,0	6,0	25,0	69

Bestell-Nr Aluverzahnung	Stk
<b>258-29048</b>	26,65
<b>258-29050</b>	32,85
<b>258-29052</b>	59,10
<b>258-29054</b>	78,80



## VHM-Frässtifte Rundbogenform (SF)

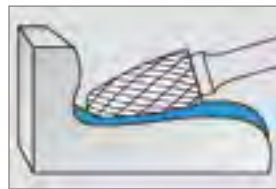
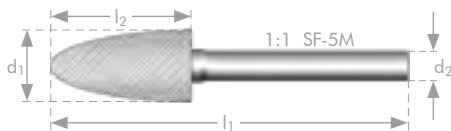

Schaft Ø 3 mm	d <sub>1</sub>	d <sub>2</sub>	l <sub>2</sub>	l <sub>1</sub>
SF-41M	3,0	3,0	6,0	38
SF-42M	3,0	3,0	12,7	38
SF-53M	5,0	3,0	12,7	38
SF-51M	6,3	3,0	12,7	50

Bestell-Nr Kreuzverzahnung	Bestell-Nr Normalverzahnung	Stk
<b>258-23678</b>	<b>258-23675</b>	7,30
<b>258-23703</b>	<b>258-23700</b>	7,30
<b>258-23753</b>	<b>258-23750</b>	17,50
<b>258-23728</b>	<b>258-23725</b>	11,95

Schaft Ø 6 mm	d <sub>1</sub>	d <sub>2</sub>	l <sub>2</sub>	l <sub>1</sub>
SF-11M	3,0	6,0	12,7	56
SF-1M	6,0	6,0	16,0	50
SF-3M	9,5	6,0	19,0	63
SF-4M	11,0	6,0	25,0	69
SF-5MZ	12,0	6,0	25,0	65
SF-13M	12,7	6,0	19,0	63
SF-5M	12,7	6,0	25,0	69
SF-6M	16,0	6,0	25,0	69
SF-7M	19,0	6,0	25,0	69
SF-14M	19,0	6,0	32,0	76
SF-15M	19,0	6,0	38,0	82

Bestell-Nr Kreuzverzahnung	Bestell-Nr Normalverzahnung	Stk
<b>258-23503</b>	<b>258-23500</b>	14,65
<b>258-23303</b>	<b>258-23300</b>	14,65
<b>258-23328</b>	<b>258-23325</b>	18,50
<b>258-23353</b>	<b>258-23350</b>	25,70
<b>258-23522</b>	<b>258-23520</b>	27,35
<b>258-23528</b>	<b>258-23525</b>	27,35
<b>258-23378</b>	<b>258-23375</b>	27,35
<b>258-23403</b>	<b>258-23400</b>	37,85
<b>258-23453</b>	<b>258-23450</b>	49,75
<b>258-23578</b>	<b>258-23575</b>	62,60
<b>258-23628</b>	<b>258-23625</b>	73,55

## VHM-Frässtifte Rundbogenform Langschaftfrässtifte

Schaft Ø 3 mm - Ø 6 mm



Schaft Ø 3 mm	d <sub>1</sub>	d <sub>2</sub>	l <sub>2</sub>	l <sub>1</sub>
SF-41ML2	3,0	3,0	14,0	50
SF-41ML3	3,0	3,0	14,0	75

Bestell-Nr Kreuzverzahnung	Bestell-Nr Normalverzahnung	Stk
<b>258-27653</b>	<b>258-27650</b>	10,10
<b>258-27678</b>	<b>258-27675</b>	11,40

Schaft Ø 6 mm	d <sub>1</sub>	d <sub>2</sub>	l <sub>2</sub>	l <sub>1</sub>
SF-1ML6	6,0	6,0	12,7	162
SF-3ML6	9,5	6,0	19,0	169
SF-5ML6	12,7	6,0	25,0	175

Bestell-Nr Kreuzverzahnung	Bestell-Nr Normalverzahnung	Stk
<b>258-26553</b>	<b>258-26550</b>	20,50
<b>258-26578</b>	<b>258-26575</b>	25,95
<b>258-26603</b>	<b>258-26600</b>	38,20

## VHM-Frässtifte Rundbogenform- Aluminiumverzahnung

Schaft Ø 6 mm

Schaft Ø 6 mm	d <sub>1</sub>	d <sub>2</sub>	l <sub>2</sub>	l <sub>1</sub>
SF-1MNF	6,0	6,0	19,0	50
SF-3MNF	9,5	6,0	19,0	63
SF-5MNF	12,7	6,0	25,0	69
SF-6MNF	16,0	6,0	25,0	69
SF-14MNF	19,0	6,0	32,0	76

Bestell-Nr Aluverzahnung	Stk
<b>258-29058</b>	18,40
<b>258-29060</b>	26,05
<b>258-29062</b>	36,60
<b>258-29064</b>	52,45
<b>258-29066</b>	72,30



## VHM-Frässtifte Spitzbogenform (SG)

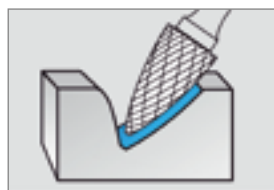
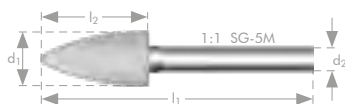

Schaft Ø 3 mm	d <sub>1</sub>	d <sub>2</sub>	l <sub>2</sub>	l <sub>1</sub>
SG-41M	3,0	3,0	6,0	38
SG-43M	3,0	3,0	9,5	38
SG-44M	3,0	3,0	12,7	38
SG-53M	5,0	3,0	12,7	38
SG-51M	6,3	3,0	12,7	50

Bestell-Nr Kreuzverzahnung	Bestell-Nr Normalverzahnung	Stk
258-24153	258-24150	7,30
258-24203	258-24200	7,30
258-24228	258-24225	7,30
258-24278	258-24275	17,50
258-24253	258-24250	11,95

Schaft Ø 6 mm	d <sub>1</sub>	d <sub>2</sub>	l <sub>2</sub>	l <sub>1</sub>
SG-1M	6,0	6,0	16,0	50
SG-2M	8,0	6,0	19,0	63
SG-3M	9,5	6,0	19,0	63
SG-3MZ	10,0	6,0	20,0	60
SG-5MZ	12,0	6,0	25,0	65
SG-13M	12,7	6,0	19,0	63
SG-5M	12,7	6,0	25,0	69
SG-6M	16,0	6,0	25,0	69
SG-7M	19,0	6,0	25,0	69
SG-15M	19,0	6,0	38,0	82

Bestell-Nr Kreuzverzahnung	Bestell-Nr Normalverzahnung	Stk
258-23853	258-23850	14,65
258-23878	258-23875	17,85
258-23903	258-23900	19,75
258-24042	258-24040	19,75
258-24046	258-24045	26,90
258-24053	258-24050	26,90
258-23928	258-23925	26,90
258-23953	258-23950	37,35
258-24003	258-24000	49,75
258-24103	258-24100	73,55

VHM-Frässtifte Spitzbogenform  
Langschaftfrässtifte, Schaft Ø 3 mm - Ø 6 mm

Schaft Ø 3 mm	d <sub>1</sub>	d <sub>2</sub>	l <sub>2</sub>	l <sub>1</sub>
SG-44ML2	3,0	3,0	14,0	50
SG-44ML3	3,0	3,0	14,0	75

Bestell-Nr Kreuzverzahnung	Bestell-Nr Normalverzahnung	Stk
258-27853	258-27850	10,10
258-27878	258-27875	11,40

Schaft Ø 6 mm	d <sub>1</sub>	d <sub>2</sub>	l <sub>2</sub>	l <sub>1</sub>
SG-1-ML6	6,0	6,0	12,7	162
SG-3-ML6	9,5	6,0	19,0	169
SG-5-ML6	12,7	6,0	25,0	175

Bestell-Nr Kreuzverzahnung	Bestell-Nr Normalverzahnung	Stk
258-26628	258-26625	20,50
258-26653	258-26650	27,60
258-26678	258-26675	37,70

## VHM-Frässtifte Flammenform (SH)

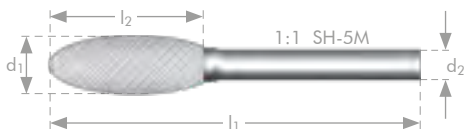

Schaft Ø 3 mm	d <sub>1</sub>	d <sub>2</sub>	l <sub>2</sub>	l <sub>1</sub>
SH-41M	3,0	3,0	6,3	38
SH-53M	5,0	3,0	9,5	38

Schaft Ø 6 mm	d <sub>1</sub>	d <sub>2</sub>	l <sub>2</sub>	l <sub>1</sub>
SH-2M	8,0	6,0	19,0	63
SH-5M	12,7	6,0	32,0	76
SH-6M	16,0	6,0	36,0	80
SH-7M	19,0	6,0	41,0	85

Bestell-Nr Kreuzverzahnung	Bestell-Nr Normalverzahnung	Stk
258-24553	258-24550	7,30
258-24603	258-24600	17,50

Bestell-Nr Kreuzverzahnung	Bestell-Nr Normalverzahnung	Stk
258-24403	258-24400	19,45
258-24428	258-24425	39,65
258-24453	258-24450	54,75
258-24503	258-24500	69,55

VHM-Frässtifte Flammenform  
Langschaftfrässtifte

Schaft Ø 3 mm - Ø 6 mm

Schaft Ø 3 mm	d <sub>1</sub>	d <sub>2</sub>	l <sub>2</sub>	l <sub>1</sub>
SH-41ML2	3,0	3,0	6,3	50
SH-41ML3	3,0	3,0	6,6	75

Schaft Ø 6 mm	d <sub>1</sub>	d <sub>2</sub>	l <sub>2</sub>	l <sub>1</sub>
SH-2ML6	8,0	6,0	19,0	169
SH-5ML6	12,7	6,0	32,0	182

Bestell-Nr Kreuzverzahnung	Bestell-Nr Normalverzahnung	Stk
258-27903	258-27900	10,10
258-27928	258-27925	11,40

Bestell-Nr Kreuzverzahnung	Bestell-Nr Normalverzahnung	Stk
258-26703	258-26700	27,30
258-26728	258-26725	55,50



## VHM-Frässtifte Kegelsenkform 60° (SJ)

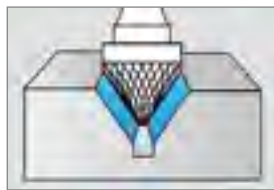
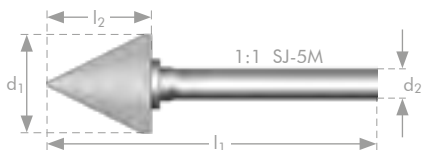

Schaft Ø 3 mm	d <sub>1</sub>	d <sub>2</sub>	l <sub>2</sub>	l <sub>1</sub>
SJ-42M	3,0	3,0	2,5	38



Bestell-Nr Kreuzverzahnung	Bestell-Nr Normalverzahnung	Stk
258-24903	258-24900	7,30

SJ-42M	5,0	3,0	4,3	37
SJ-42M	3,0	3,0	2,6	38

Bestell-Nr Feinverzahnung	Stk
258-24905	29,20
258-24907	17,85

Schaft Ø 6 mm	d <sub>1</sub>	d <sub>2</sub>	l <sub>2</sub>	l <sub>1</sub>
SJ-1M	6,0	6,0	4,0	50
SJ-3M	9,5	6,0	8,0	55
SJ-5M	12,7	6,0	11,0	58
SJ-6M	16,0	6,0	14,5	61
SJ-7M	19,0	6,0	17,5	65
SJ-9M	25,0	6,0	24,5	68

Bestell-Nr Kreuzverzahnung	Bestell-Nr Normalverzahnung	Stk
258-24678	258-24675	12,95
258-24703	258-24700	16,90
258-24728	258-24725	20,55
258-24753	258-24750	27,35
258-24803	258-24800	35,95
258-24853	258-24850	57,70

## VHM-Frässtifte Kegelsenkform 90° (SK)

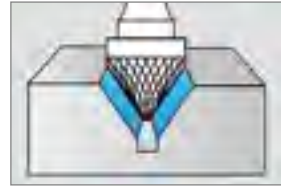
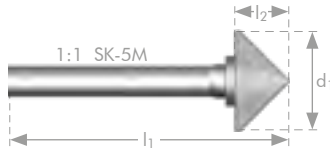

Schaft Ø 3 mm	d <sub>1</sub>	d <sub>2</sub>	l <sub>2</sub>	l <sub>1</sub>
SK-42M	3,0	3,0	1,5	38



Bestell-Nr Kreuzverzahnung	Bestell-Nr Normalverzahnung	Stk
<b>258-25153</b>	<b>258-25150</b>	7,30

Bestell-Nr Feinverzahnung	Stk
<b>258-25155</b>	27,75
<b>258-25157</b>	31,40

SK-42M	5,0	3,0	2,5	35
SK-42M	6,0	3,0	3,0	36

Schaft Ø 6 mm	d <sub>1</sub>	d <sub>2</sub>	l <sub>2</sub>	l <sub>1</sub>
SK-1M	6,0	6,0	3,0	50
SK-3M	9,5	6,0	4,7	52
SK-5M	12,7	6,0	6,3	54
SK-6M	16,0	6,0	8,0	57
SK-7M	19,0	6,0	9,5	58
SK-9M	25,0	6,0	12,7	60

Bestell-Nr Kreuzverzahnung	Bestell-Nr Normalverzahnung	Stk
<b>258-24928</b>	<b>258-24925</b>	12,95
<b>258-24953</b>	<b>258-24950</b>	16,90
<b>258-24978</b>	<b>258-24975</b>	20,55
<b>258-25003</b>	<b>258-25000</b>	27,35
<b>258-25053</b>	<b>258-25050</b>	35,95
<b>258-25103</b>	<b>258-25100</b>	57,70

## VHM-Frässtifte Rundkegelform (SL)

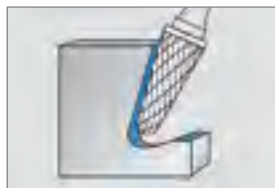
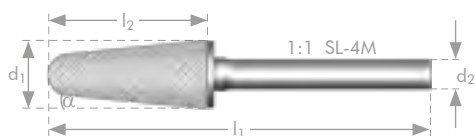

Schaft Ø 3 mm	d <sub>1</sub>	d <sub>2</sub>	l <sub>2</sub>	l <sub>1</sub>	α
SL-41M	3,0	3,0	9,0	38	8°
SL-42M	3,0	3,0	12,7	38	8°
SL-53M	5,0	3,0	12,7	38	14°

Bestell-Nr Kreuzverzahnung	Bestell-Nr Normalverzahnung	Stk
<b>258-25403</b>	<b>258-25400</b>	7,30
<b>258-25428</b>	<b>258-25425</b>	7,30
<b>258-25453</b>	<b>258-25450</b>	17,50

Schaft Ø 6 mm	d <sub>1</sub>	d <sub>2</sub>	l <sub>2</sub>	l <sub>1</sub>	α
SL-1M	6,0	6,0	16,0	50	14°
SL-2M	8,0	6,0	22,0	69	14°
SL-3M	9,5	6,0	27,0	74	14°
SL-4M	12,7	6,0	28,0	76	14°
SL-5M	16,0	6,0	30,0	77	14°
SL-7M	19,0	6,0	38,0	85	14°

Bestell-Nr Kreuzverzahnung	Bestell-Nr Normalverzahnung	Stk
<b>258-25178</b>	<b>258-25175</b>	15,00
<b>258-25203</b>	<b>258-25200</b>	19,65
<b>258-25228</b>	<b>258-25225</b>	23,70
<b>258-25253</b>	<b>258-25250</b>	28,95
<b>258-25278</b>	<b>258-25275</b>	51,70
<b>258-25353</b>	<b>258-25350</b>	75,15

## VHM-Frässtifte Rundkegelform Langschafffrässtifte

Schaft Ø 3 mm - Ø 6 mm

Schaft Ø 3 mm	d <sub>1</sub>	d <sub>2</sub>	l <sub>2</sub>	l <sub>1</sub>	α
SL-42ML2	3,0	3,0	12,7	50	8°
SL-42ML3	3,0	3,0	12,7	75	8°

Schaft Ø 6 mm	d <sub>1</sub>	d <sub>2</sub>	l <sub>2</sub>	l <sub>1</sub>	α
SL-1ML6	6,0	6,0	16,0	166	14°
SL-3ML6	9,5	6,0	27,0	177	14°
SL-4ML6	12,7	6,0	28,0	178	14°



Bestell-Nr Kreuzverzahnung	Bestell-Nr Normalverzahnung	Stk
<b>258-27953</b>	<b>258-27950</b>	10,10
<b>258-27978</b>	<b>258-27975</b>	11,40

Bestell-Nr Kreuzverzahnung	Bestell-Nr Normalverzahnung	Stk
<b>258-26753</b>	<b>258-26750</b>	21,00
<b>258-26778</b>	<b>258-26775</b>	33,15
<b>258-26803</b>	<b>258-26800</b>	40,55

## VHM-Frässtifte Rundkegelform - Aluminiumverzahnung

Schaft Ø 6 mm

Schaft Ø 6 mm	d <sub>1</sub>	d <sub>2</sub>	l <sub>2</sub>	l <sub>1</sub>	α
SL-3MNF	6,0	6,0	19,0	50	14°
SL-4MNF	12,7	6,0	19,0	63	14°
SL-5MNF	16,0	6,0	25,0	69	14°

Bestell-Nr Aluverzahnung	Stk
<b>258-29070</b>	33,35
<b>258-29072</b>	46,05
<b>258-29074</b>	73,90



## VHM-Frässtifte Spitzkegelform (SM)

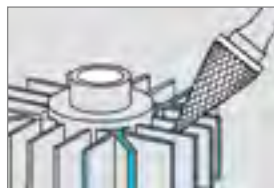
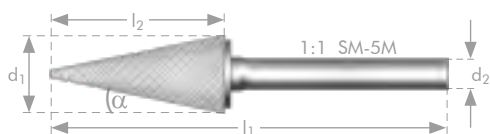

Schaft Ø 3 mm	d <sub>1</sub>	d <sub>2</sub>	l <sub>2</sub>	l <sub>1</sub>	α
SM-41M	3,0	3,0	8,9	38	12°
SM-42M	3,0	3,0	11,0	38	14°
SM-43M	3,0	3,0	16,0	38	7°
SM-53M	5,0	3,0	12,7	38	16°
SM-51M	6,3	3,0	12,7	54	22°

Bestell-Nr Kreuzverzahnung	Bestell-Nr Normalverzahnung	Stk
<b>258-25678</b>	<b>258-25675</b>	7,30
<b>258-25703</b>	<b>258-25700</b>	7,30
<b>258-25728</b>	<b>258-25725</b>	7,30
<b>258-25778</b>	<b>258-25775</b>	17,50
<b>258-25753</b>	<b>258-25750</b>	11,95

Schaft Ø 6 mm	d <sub>1</sub>	d <sub>2</sub>	l <sub>2</sub>	l <sub>1</sub>	α
SM-1M	6,0	6,0	12,7	50	22°
SM-2M	6,0	6,0	19,0	50	14°
SM-3M	6,0	6,0	25,0	50	10°
SM-4M	9,5	6,0	16,0	63	28°
SM-5M	12,7	6,0	22,0	69	28°
SM-6M	16,0	6,0	25,0	73	31°

Bestell-Nr Kreuzverzahnung	Bestell-Nr Normalverzahnung	Stk
<b>258-25503</b>	<b>258-25500</b>	14,25
<b>258-25528</b>	<b>258-25525</b>	15,00
<b>258-25553</b>	<b>258-25550</b>	16,05
<b>258-25578</b>	<b>258-25575</b>	23,70
<b>258-25603</b>	<b>258-25600</b>	29,75
<b>258-25628</b>	<b>258-25625</b>	39,65

VHM-Frässtifte Spitzkegelform  
Langschaftfrässtifte

Schaft Ø 3 mm

Schaft Ø 3 mm	d <sub>1</sub>	d <sub>2</sub>	l <sub>2</sub>	l <sub>1</sub>	α
SM-42ML2	3,0	3,0	11,0	50	14°
SM-42ML3	3,0	3,0	11,0	75	14°

Bestell-Nr Kreuzverzahnung	Bestell-Nr Normalverzahnung	Stk
<b>258-28053</b>	<b>258-28050</b>	10,10
<b>258-28078</b>	<b>258-28075</b>	11,40

## VHM-Frässtifte Winkelform (SN)

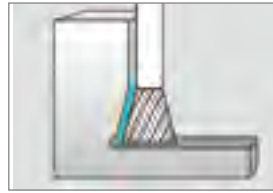
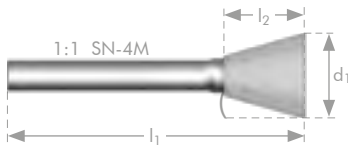

Schaft Ø 3 mm	$d_1$	$d_2$	$l_2$	$l_1$	$\alpha$
SN-41M	2,5	3,0	3,0	38	10°
SN-42M	3,0	3,0	4,0	38	10°
SN-53M	5,0	3,0	6,3	38	10°
SN-51M	6,3	3,0	6,0	44	10°

Bestell-Nr Kreuzverzahnung	Bestell-Nr Normalverzahnung	Stk
<b>258-26028</b>	<b>258-26025</b>	7,30
<b>258-26053</b>	<b>258-26050</b>	7,30
<b>258-26103</b>	<b>258-26100</b>	17,50
<b>258-26078</b>	<b>258-26075</b>	11,95

Schaft Ø 6 mm	$d_1$	$d_2$	$l_2$	$l_1$	$\alpha$
SN-1M	6,0	6,0	8,0	50	10°
SN-2M	9,5	6,0	9,5	53	13°
SN-4M	12,7	6,0	12,7	57	28°
SN-6M	16,0	6,0	19,5	63	18°
SN-7M	19,0	6,0	16,0	60	30°

Bestell-Nr Kreuzverzahnung	Bestell-Nr Normalverzahnung	Stk
<b>258-25853</b>	<b>258-25850</b>	14,35
<b>258-25878</b>	<b>258-25875</b>	20,95
<b>258-25903</b>	<b>258-25900</b>	29,60
<b>258-25928</b>	<b>258-25925</b>	38,00
<b>258-25978</b>	<b>258-25975</b>	42,70

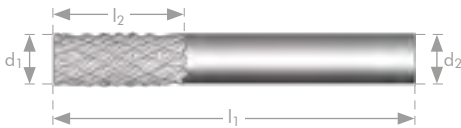

## Stirn glatt

d <sub>1</sub>	d <sub>2</sub>	l <sub>2</sub>	l <sub>1</sub>	Bestell-Nr unbeschichtet	Stk
1,6	3	5	38	258-83001	10,90
2,4	3	9,5	38	258-83002	11,60
3,0	3	12	38	258-83003	11,10
4	4	16	50	258-83004	18,20
4	6	16	50	258-83005	19,80
6	6	19	50	258-83006	19,80
6	6	19	63	258-83007	19,80
6	6	25	75	258-83008	24,55
8	8	25	63	258-83009	41,10
10	10	25	75	258-83010	51,25
12	12	25	75	258-83011	70,35

## Stirn wie Frässtift

d <sub>1</sub>	d <sub>2</sub>	l <sub>2</sub>	l <sub>1</sub>	Bestell-Nr unbeschichtet	Stk
1,6	3	5	38	258-83015	13,00
2,4	3	9,5	38	258-83016	13,00
3,0	3	12	38	258-83017	12,40
4	4	16	50	258-83018	20,20
4	6	16	50	258-83019	22,15
6	6	19	50	258-83020	22,15
6	6	19	63	258-83021	22,15
6	6	25	75	258-83022	26,70
8	8	25	63	258-83023	43,85
10	10	25	75	258-83024	55,70
12	12	25	75	258-83025	77,40

## Fräserstirn

d <sub>1</sub>	d <sub>2</sub>	l <sub>2</sub>	l <sub>1</sub>	Bestell-Nr unbeschichtet	Stk
1,6	3	5	38	258-83030	13,05
2,4	3	9,5	38	258-83031	14,10
3,0	3	12	38	258-83032	13,40
4	4	16	50	258-83033	21,05
4	6	16	50	258-83034	23,60
6	6	19	50	258-83035	23,60
6	6	19	63	258-83036	23,60
6	6	25	75	258-83037	27,95
8	8	25	63	258-83038	45,55
10	10	25	75	258-83039	57,85
12	12	25	75	258-83040	81,20

## Bohrerspitze

d <sub>1</sub>	d <sub>2</sub>	l <sub>2</sub>	l <sub>1</sub>	Bestell-Nr unbeschichtet	Stk
1,6	3	5	38	258-83045	13,80
2,4	3	9,5	38	258-83046	14,90
3,0	3	12	38	258-83047	14,20
4	4	16	50	258-83048	21,20
4	6	16	50	258-83049	24,60
6	6	19	50	258-83050	24,60
6	6	19	63	258-83051	24,60
6	6	25	75	258-83052	28,85
8	8	25	63	258-83053	46,90
10	10	25	75	258-83054	60,10
12	12	25	75	258-83055	84,95

## Schnittwertempfehlung

Werkstoff GFK	Schneidendurchmesser (mm)			
	Ø 1,6	Ø 2,4	Ø 3	Ø 4
Drehzahl (min <sup>-1</sup> )	40.000 - 45.000	25.000 - 30.000	20.000 - 25.000	20.000 - 24.000
Vorschub (mm/sec)	1.000 - 1.500	1.100 - 1.800	1.100 - 1.800	900 - 1.700
	Ø 6	Ø 10	Ø 12	
Drehzahl (min <sup>-1</sup> )	20.000 - 24.000	15.000 - 20.000	10.000 - 15.000	
Vorschub (mm/sec)	900 - 1.700	700 - 1.500	500 - 1.300	